

SANDPIPER®

A WARREN RUPP, INC. BRAND | SANDPIPERPUMP.COM



IBEX

PRODUCT CATALOG



SANDPIPER®
Signature
SERIES

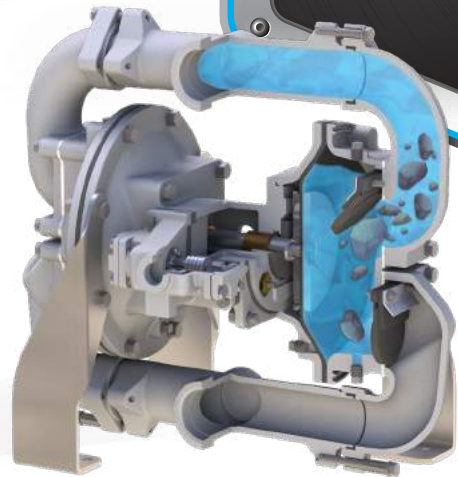

Heavy Duty Flap Valve

For fluids containing up to line size solids.

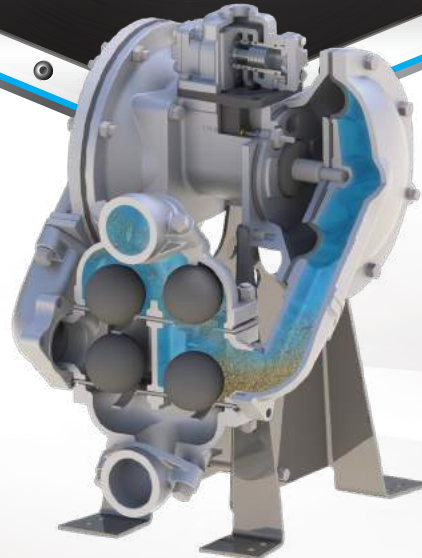

Heavy Duty Ball Valve

For fluids containing settling, suspended & floating solids.

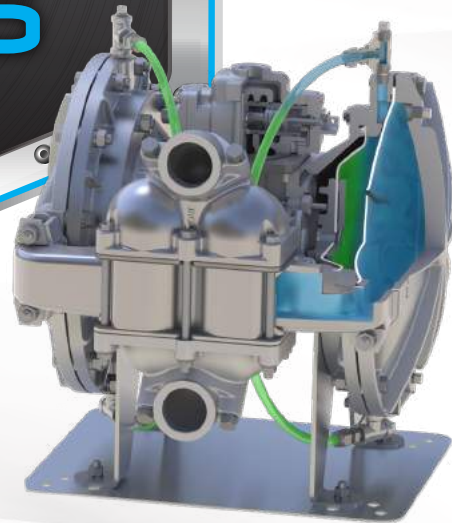

Containment Duty Ball Valve

The only complete line of AODD pumps featuring superior fluid containment; protecting your people, environment and pump.

What is

EVOLUTION



OPTIMIZED PERFORMANCE |

Optimized performance without sacrificing **proven reliability**. These pumps have undergone an engineering **EVOLUTION**, leveraging trusted and proven product designs to **improve their performance** by application of advanced engineering methods. Unlike the competition, these pumps are **fully interchangeable** with prior models.

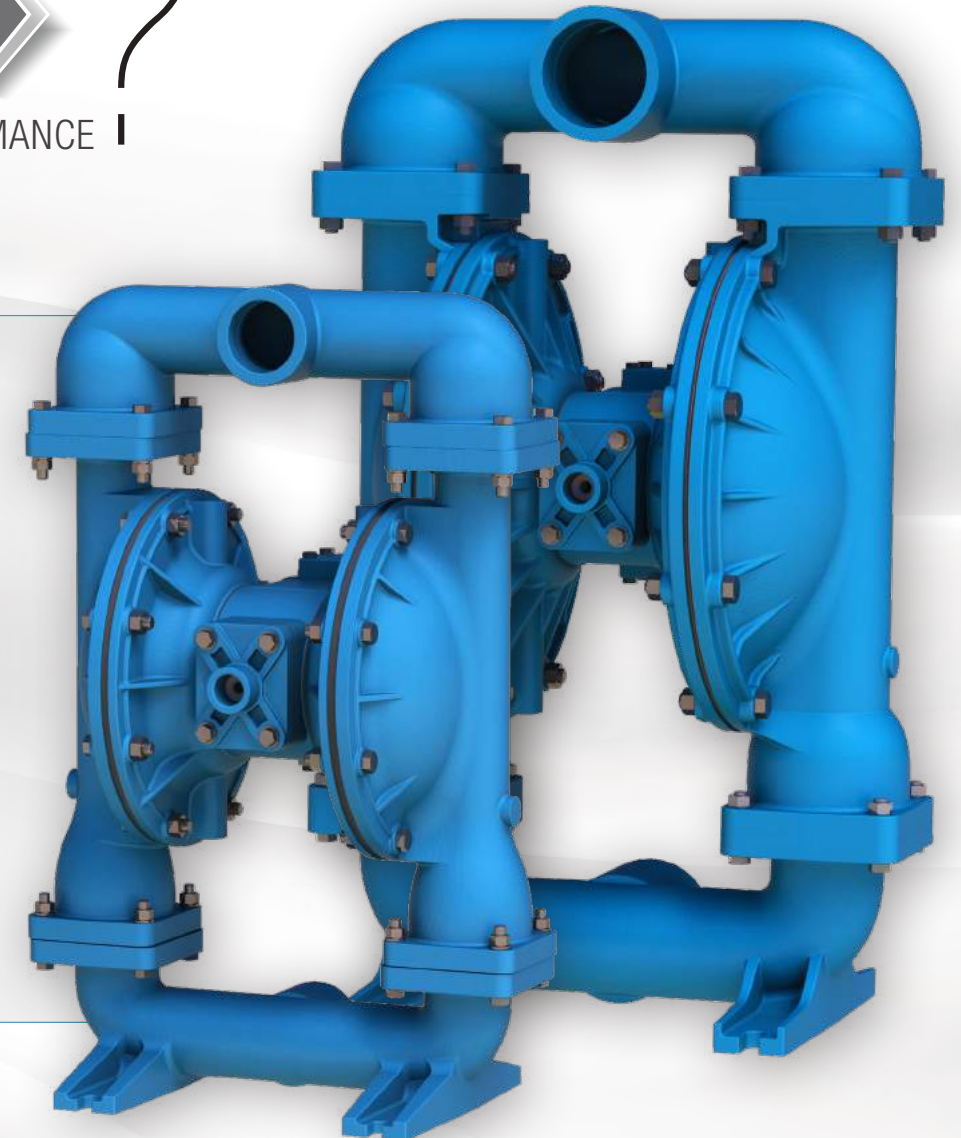

OUR SIGNATURE ENSURES YOUR SUCCESS

SANDPIPER Signature Series AODD pumps are engineered to deliver industry leading durability and performance, even for your most severe applications and environments.

LEARN MORE AT: SANDPIPERPUMP.COM/SIGNATURE-SERIES

WHEREVER YOU SEE THIS BADGE:

These pumps have gone through our Evolution performance improvement. Watch for more Engineering Evolutions to come in the near future!

LEARN MORE AT: SANDPIPERPUMP.COM/EVOLUTION

ENGINEERED PUMPING SOLUTIONS WITH MORE WAYS THAN ONE

For over 50 years, SANDPIPER, a Warren Rupp, Inc. brand, has been a leading global Air Operated Double Diaphragm (AODD) pump company, featuring the broadest range of products to meet the needs of a wide variety of applications. Decades of innovation, combined with world class engineering expertise, allows the SANDPIPER team to create products that meet the demand of an ever-changing marketplace.

LEARN MORE AT SANDPIPERPUMP.COM

Certified Quality

CE
Products are Declared Compliant to Directive 2006/42/EC - Machinery Safety

ATEX
Products are Either EC-Type or Type Examination Certified to Directive 94/9/EC - Machinery for Use in Potentially Explosive Atmospheres

EurAsian Conformity
Certified to sell products into Eurasian Economic Union

CSA
G-Series Natural Gas Operated Pumps are CSA Certified to ANSI LC6:2008 and Canadian Technical Letter No. R-14

ISO 9001 Quality
Quality System Certified to Ensure Every Product is Made with Care and Quality Control

ABS Marine & Offshore
American Bureau of Shipping Type Approval of Metal SANDPIPER Pumps and Tranquillizer Surge Suppressors

FDA
FDA Accepted Materials of Construction

EC1935
Food Processing T-Series Model Plastic and Elastomer Food Contact Components Meet the Requirements of EU Regulation 1935/2004/EC

Underwriters Laboratories
U1F Model Pumps are UL Listed to UL79 Standard for Use in Fuel Transfer and Pumping Flammable Fluids

Global Coverage
Contacts in 75 Countries and Over 1 Million Pumps Sold

World Headquarters
800 N. Main Street
Mansfield, Ohio 44902
USA

Pump Technology
Air Operated Double Diaphragm Pumps (AODD)

Table of Contents

| | | | |
|-------------------------------------|----|-----------------------------------------|----|
| Why Choose AODD Pumps | 6 | Heavy Duty Flap Valve Pumps | 20 |
| AODD Pump Operation | 8 | Heavy Duty Ball Valve Pumps | 28 |
| Installation Versatility | 9 | Containment Duty Ball Valve Pumps | 32 |
| The SANDPIPER Advantage | 10 | Standard Duty Ball Valve Pumps | 36 |
| Engineering Capabilities | 12 | Special Duty Pumps | 44 |
| Markets & Applications | 14 | Accessories | 58 |
| Pump Selection | 16 | Diaphragm Selection | 64 |
| Exclusive Pump Configurations | 18 | Genuine Parts Service Kits | 66 |

WHY CHOOSE AODD PUMPS

PERFORMING IN THE MOST CHALLENGING APPLICATIONS, AODD PUMPS DELIVER UNIQUE BENEFITS THAT ARE UNRIVALED BY OTHER PUMP TECHNOLOGIES

AODD pumps are air (or natural gas) operated displacement type pumps which uniquely differ from all other positive displacement pumps. As a result of air pressure acting on the entire surface of the diaphragm, the diaphragm is in a balanced condition while pumping. This measurably extends diaphragm life over that of mechanically operated diaphragm pumps. Because compressed air is limited, the maximum pressure developed by the pump is also safely limited. Thus, AODD pumps are appropriately selected for on-demand intermittent requirements.

Unique Performance

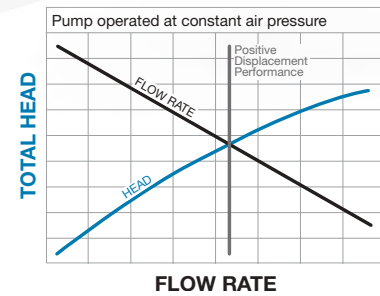

Although the AODD pump is a displacement type, it is actually a hybrid and defies strict classification. While its pressure versus capacity characteristics resemble those of a centrifugal pump, it is best defined as a sealless, non (or semi) positive displacement pump.



Features & Benefits

-  Dry-run without damaging the pump or system
-  Pumps solid laden fluids without pump or product damage
-  Self-priming, works in suction lift applications
-  Deadheads safely, with no pump or product damage
-  Shear sensitive, does not shear or separate product being pumped
-  No electricity required, and can be fully grounded
-  Low initial purchase price compared to other technologies
-  Submersible, can be submerged completely without safety or performance issues
-  Sealless design, no expensive mechanical seals or packing are required
-  Variable flow and head pressures, without sophisticated controls
-  Optional bottom discharge porting depending on fluid characteristics

| AODD VS. OTHERS | AODD | Kinetic Centrifugal | Positive Displacement | | | | |
|----------------------------------------------------------------|------|---------------------|-----------------------|------|---------------------|--------------------|----------------|
| | | Centrifugal | Lobe | Gear | Progressive (Screw) | Peristaltic (Hose) | Piston/Plunger |
| Variable Flow & Head Control <i>(inherently adjustable)</i> | ✓ | ✓ | ✓ | ✓ | ! | ! | ✓ |
| Deadheads Safely <i>(at zero energy consumption)</i> | ✓ | ! | ! | ! | ! | ! | ! |
| Dry-Running | ✓ | X | X | X | X | X | X |
| Dry-Priming <i>(lift installations)</i> | ✓ | X | X | ✓ | X | X | ! |
| No Installation Alignment Required | ✓ | X | X | X | X | X | X |
| No Electrical Installation Required | ✓ | X | X | X | X | X | X |
| Portability | ✓ | ✓ | ! | ! | ! | ✓ | ! |
| Submersible | ✓ | ! | X | X | X | X | X |
| Sealless <i>(no packing or mechanical seals)</i> | ✓ | ! | ! | ! | ! | ! | ! |
| No Slip <i>(thin liquids)</i> | ✓ | ✓ | ! | ! | ! | ✓ | ! |
| Cavitation Tolerance <i>(low NPSHa)</i> | ✓ | X | ! | ! | ✓ | ! | ! |
| Low Shear & Degradation | ✓ | X | ✓ | ✓ | ! | ! | ! |

✓ = Suitable ! = Limitations X = Not Recommended

OPERATION & INSTALLATION

FIXED, MOUNTED OR PORTABLE SANDPIPER PUMPS ARE DESIGNED TO PERFORM IN THE MOST DIFFICULT CONDITIONS

AODD Pump Operation

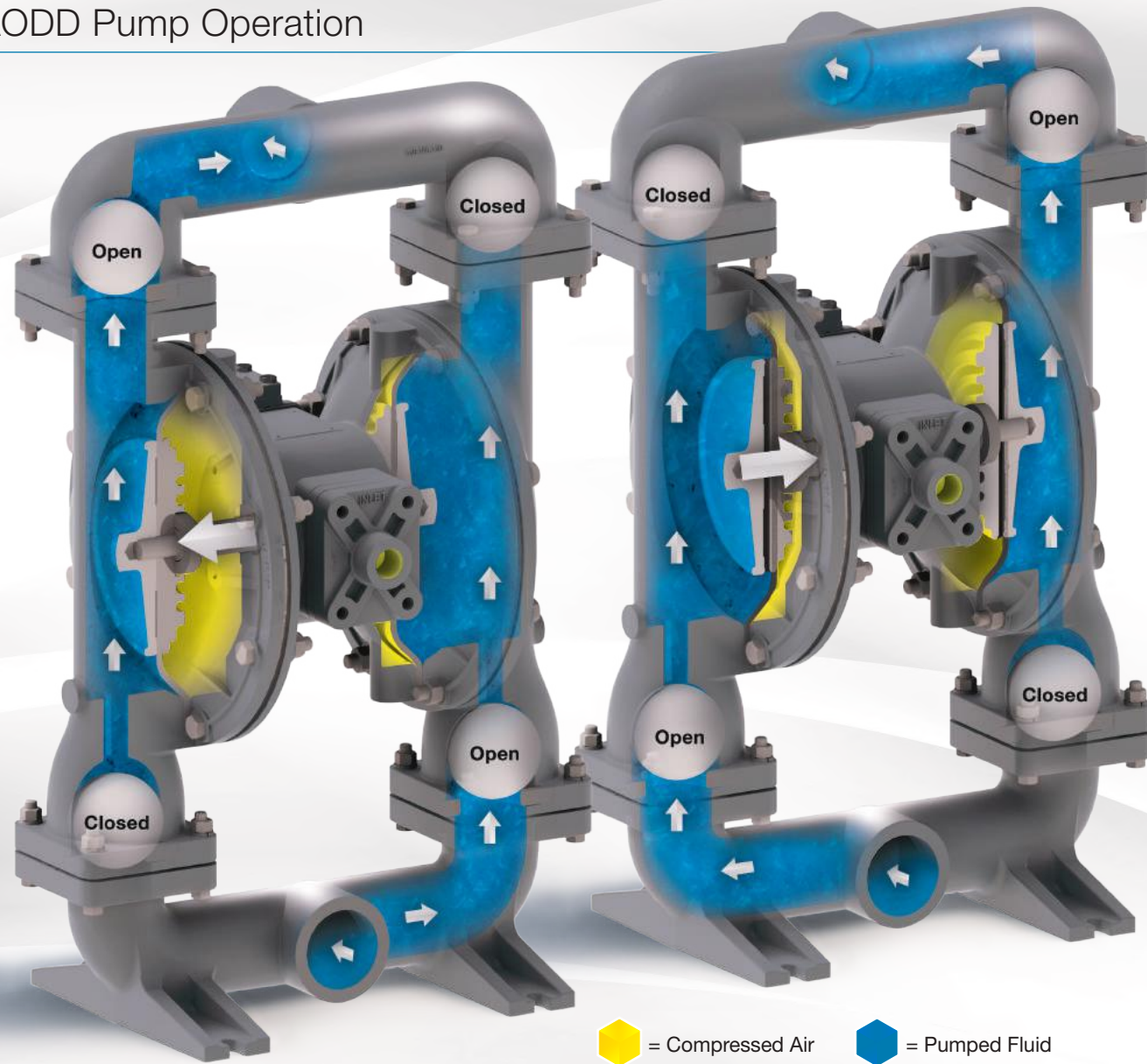

1 Suction Cycle
 Compressed air fills left inner chamber, causing the opposing diaphragm to create suction, lifting the lower valve ball, pulling in fluid at inlet. Simultaneously, the left chamber is in "Discharge" cycle.

2 Discharge Cycle
 Compressed air fills right inner chamber, causing upper valve ball to open and discharge fluid. Simultaneously, the left chamber is in "Suction" cycle.

Installation Versatility

All installations are run-dry capable. Electricity and heat generation are not required for optimum performance.

- Suction Lift**
- Self-priming
 - High vacuum capable
 - Max lift of 32' (9.8m)

- Flooded Suction**
- Preferred for viscous fluids
 - Most common application
 - Screened inlet option

- Submerged**
- Capable of full submersion
 - Screened inlet option

NOTE: Consult your distributor or owners manual for proper materials of construction and installation for your application.

THE SANDPIPER ADVANTAGE

WITH NEARLY 50 YEARS OF PUMPING EXPERTISE, WE PROVIDE APPLICATION DRIVEN PUMPING SOLUTIONS

All Bolted Construction
Superior reliability is defined by our all bolted pump construction that allows for instant part alignment, uniform torquing of seals, and high pressure capabilities

Various Power Sources
SANDPIPER pumps operate at optimum performance using compressed air, but we also have pumps available for running off of your local reserve of natural gas
[LEARN MORE ON PAGE 46](#)

Tested Quality
SANDPIPER pumps are 100% wet tested after final assembly to ensure proper functionality; Testing includes, but is not limited to, deadheading, priming, and sealing

ESADS+Plus Air Valve
Externally Serviceable Air Distribution System

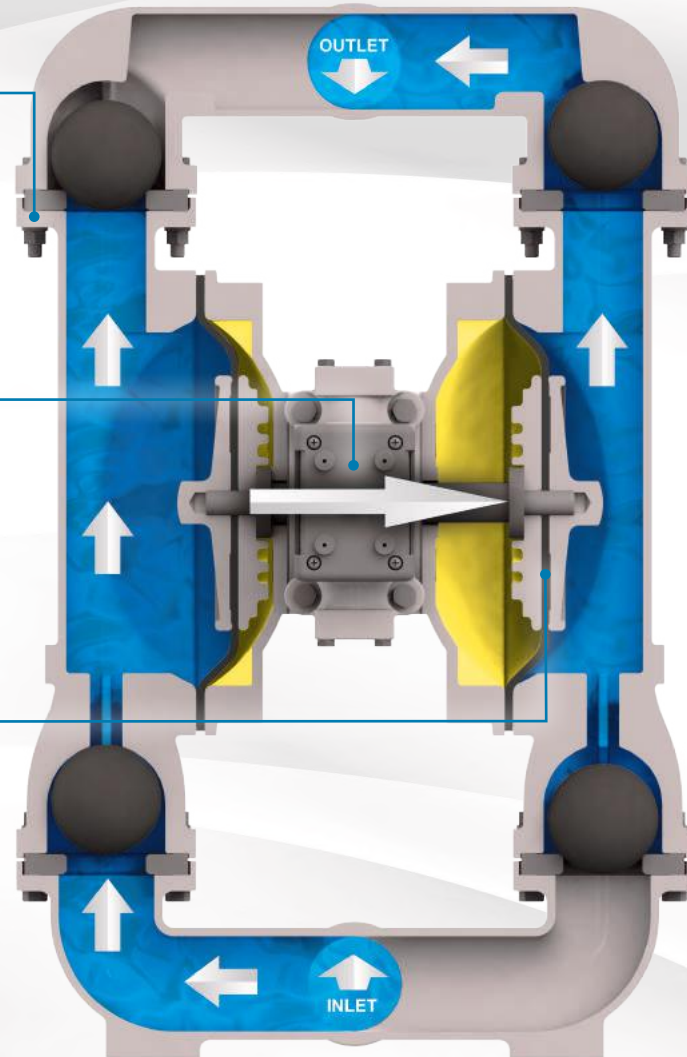

Superior Performance

Hinge pads exert positive pressure on the flaps allowing the pump to operate in virtually any position, helping deliver superior suction lift and flow rates

Flap Check Valve

Flap check valves allow for maximum solids passage of up to 3" (75mm)

Guaranteed Connecting Rod

Our durable, corrosion resistant 416 (Martensitic) and/or 316 (Austenitic) Stainless Steel diaphragm connecting rod is guaranteed not to yield under tension, compression, or bending



ROBUST DIAPHRAGM CONNECTING ROD

Guaranteed not to yield under tension, compression, or bending.



5 YEAR LIMITED PRODUCT WARRANTY

5 Year Guarantee for defects in material or workmanship.



ESADS+PLUS AIR DISTRIBUTION SYSTEM

Allows for quick and easy access to the pilot and spool valves.



Bottom Discharge Porting

Eliminate the damage from settling solids in your pump, with the exclusive bottom discharge capabilities of our Heavy Duty Ball Valve and Heavy Duty Flap Valve pump lines.

Prevent broken diaphragm plates

Eliminate diaphragm rod damage

Ensure even diaphragm wear for longevity

See our connecting rod guarantee

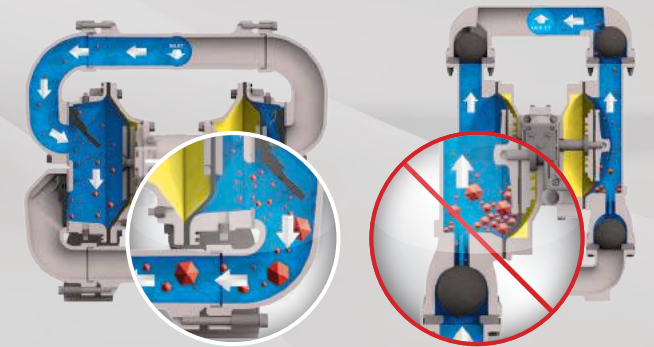

Bottom Discharge

Top Discharge

ENGINEERING CAPABILITIES

NO MATTER THE CIRCUMSTANCES, WE PROVIDE CUSTOM ENGINEERED SOLUTIONS TO MAXIMIZE THE PRODUCTIVITY OF ALL PROCESSES

Custom Engineered Systems

Some examples of our custom systems include:

- Skid systems
- High pressure, filter press feed systems
- Mobile skid systems
- Custom environmental protection packaging
- Heat jacket systems
- Nuclear industry waste handling and flushing systems

Quality Assurance

To complete the pump assembly process, the following tests are run to ensure a quality built product:

1. Dry Cycled Test

- Checked for rhythmic cycling
- Checked for abnormal vibrations
- Checked for motion abnormalities

2. Wet Cycled Test

- Checked for dry priming
- Checked for cycling characteristics
- Checked for abnormal noise levels

3. Vacuum Characteristics Test

4. Dead Head Characteristics Test

- Checked for maximum fluid pressure
- Checked for leakage
- Checked for valving bypass

5. Visual Inspection

- Hardware checked
- Mating surfaces checked
- Paint quality checked
- Packaging checked

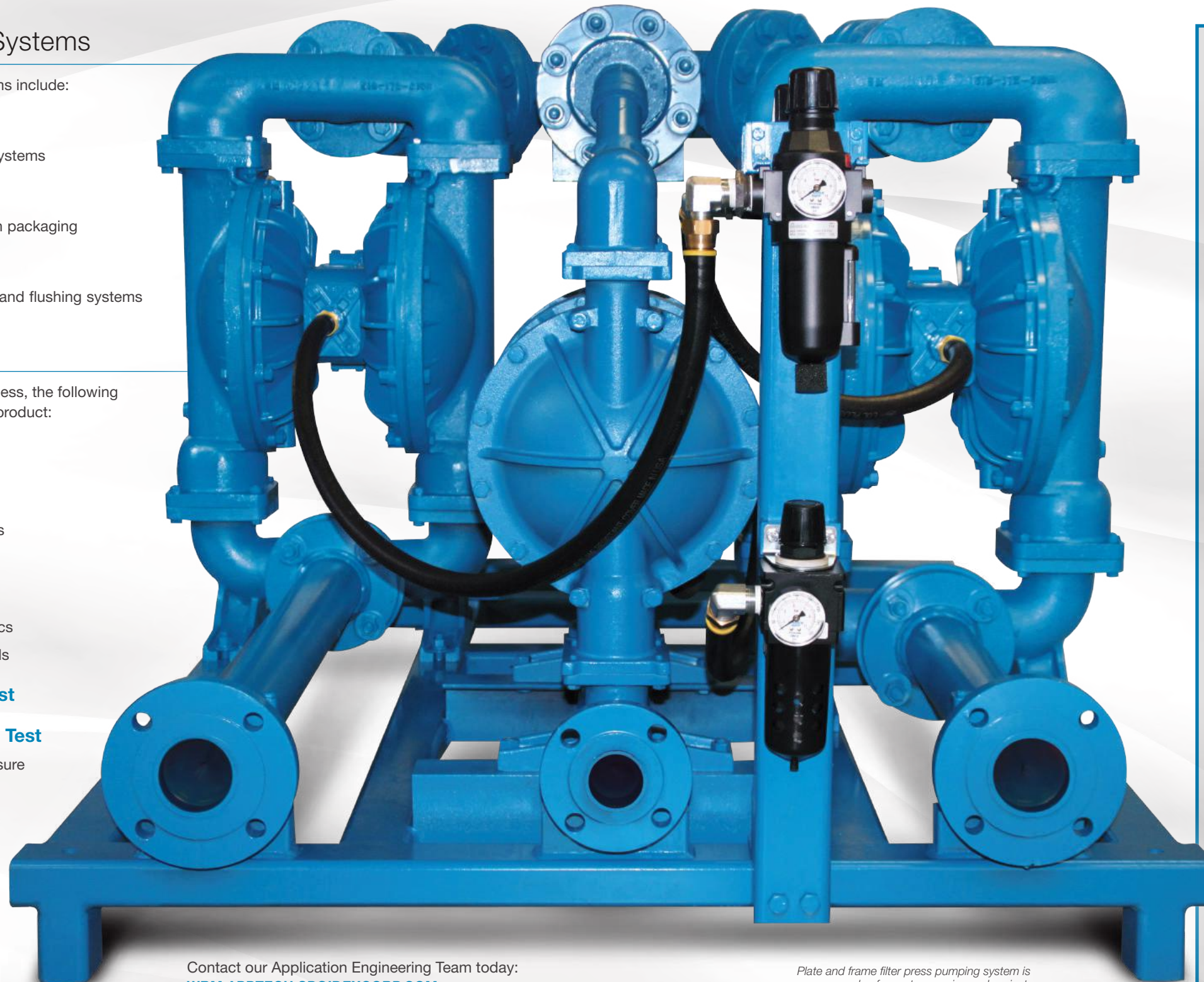

Contact our Application Engineering Team today:
WRM.APPTECH.SP@IDEXCORP.COM

Plate and frame filter press pumping system is an example of a custom engineered project.

Product Services



Performance Testing

Assembly cycle with hold pressure vacuum readings (standard), one-point head capacity, and dry lift



Pressure Testing

Hydro/pneumatic testing 90 psi (standard), hydro/pneumatic 1.5 times maximum operating pressure



Repair Services

Pump repair services for labor only



Material & Pump Certificates

Certificate of origin, conformance (pump) and compliance (material), material tests reports, non-certified or certified dimensional outlines (contact SANDPIPER Application Engineering to order)



Custom Coating

Epoxy, water based, two part (exterior only), customer specific, PTFE, Halar®, nickel plated midsection



Custom Products

Custom and engineered products, product dimensional outlines and systems



Custom Nameplates

Custom stainless steel nameplates (4 lines, 24 letter maximum)



Material Testing

PMI (Positive Material Identification), hardness testing, liquid penetrant testing, radiographic testing, magnetic particle testing, and others upon request



Additional Pump Testing

Impact test, seismic test, sound test, and others upon request

HALAR is a registered trademark of Solvay Solexis, Inc.

MARKETS & APPLICATIONS

SANDPIPER PUMPS ARE BUILT TO EXCEED THE DEMANDS OF YOUR SUMP WASTE TREATMENT AND OTHER APPLICATIONS LISTED BELOW

Automotive

Applications include oil transfer, fuel transfer, machine coolant, auto wash, auto lube and much more



Marine

Applications include oil transfer, fuel transfer, cargo cleanup, deck dewatering, cargo oil transfer, lubricants transfer and much more



Ceramics

Applications include batching, mixing, casting machines, day tank transfer, mold filling / cleaning, glaze spray, slip transfer / recirculation and much more



Mining

Applications include oil transfer, fuel transfer, water evacuation, mine face dewatering, drift dewatering and much more



Chemical

Applications include packaging, drum / tote, processing, injection, mixing and much more



Pharma / Personal Care

Applications include day tank transfer, batching, chemical feed, FDA compliant, personal hygienic / cosmetics and much more



Coatings

Applications include pigment milling, paint filtration, mixing tanks, filling machines, tank transfer, low shear requirements and much more



Pulp & Paper

Applications include bulk transfer, day tank transfer, batching, bleaching, converter / packaging, adhesives / ink and much more



Construction

Applications include portable utility, oil transfer, fuel transfer, site dewatering, seal coating, road striping, municipal utility and much more



Oil & Gas

Applications include natural gas fields, service rigs, offshore platform requirements, settling pond transfer, diesel fuel transfer, spill clean-up, salt water transfer / disposal, flare knockout and much more



Food Processing

Applications include food packaging, product transfer, wine tank over, FDA compliance, low degradation requirements, wine fermentation / pumpover and much more



Wastewater

Applications include municipal portable utility, neutralize wastewater, waste activated sludge, return activated sludge, thickened sludge, belt press feed and much more



SCAN FOR A COMPLETE LIST OF
MARKETS & APPLICATIONS
SANDPIPERPUMP.COM/MARKETS



PUMP SELECTION

A FUNDAMENTAL REVIEW OF FLUID CHARACTERISTICS, INTENDED INSTALLATION & DUTY REQUIREMENTS ARE RECOMMENDED FOR “BEST FIT” DESIGN SELECTIONS

Pump Characteristics

Whether measuring mean time between failures, repairs, changes or maintenance, this design selection best practice will ensure the longest pump life.

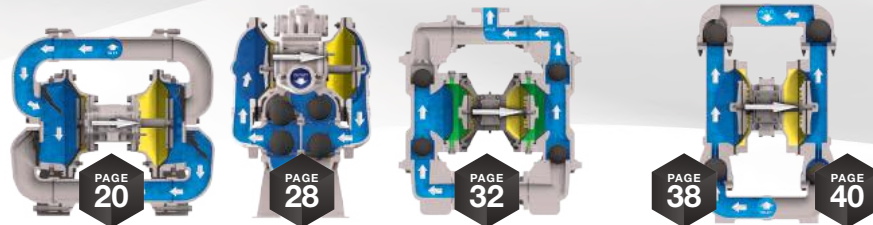

| SIGNATURE CONFIGURATIONS | | Heavy Duty Flap Valve | Heavy Duty Ball Valve | Containment Duty Ball Valve | Standard Duty Ball Valve - Metallic | Standard Duty Ball Valve - Non-Metallic |
|--------------------------|----------------------------------|-----------------------------|-----------------------------|-----------------------------|-------------------------------------|-----------------------------------------|
| Specifications | Suction / Discharge Port Sizes | 1" through 4" | 1" through 4" | 1" through 3" | ¼" through 3" | ¼" through 3" |
| | Max Flow Rate Per Minute | 310 Gal. (1173 L) | 300 Gal. (1136 L) | 260 Gal. (988 L) | 285 Gal. (1079 L) | 280 Gal. (1060 L) |
| | Max Discharge Heads | 289' (88m) of water @125psi | 289' (88m) of water @125psi | 289' (88m) of water @125psi | 289' (88m) of water @125psi | 231' (70m) of water @100psi |
| | Max Displacement Per Stroke | 1.62 Gal. (6.15 L) | 1.8 Gal. (6.8 L) | 1.25 Gal. (4.73 L) | 0.94 Gal. (3.56 L) | 0.9 Gal. (3.41 L) |
| | Max Dry Prime | 24' (7m) | 20' (6m) | 18' (5.5m) | 20' (6m) | 20' (6m) |
| | Max Solids Handling | 3" (75mm) | .88" (22mm) | .44" (10mm) | .38" (10mm) | .71" (18mm) |
| Fluid Characteristics | Water | + | + | + | + | + |
| | Suspended Solids | + | + | ✓ | + | ✓ |
| | Non-Suspended Solids | + | ! | ✗ | ! | ✗ |
| | Line Size Solids | + | ✗ | ✗ | ✗ | ✗ |
| | Sludge / Slurry | + | + | ! | ✓ | ! |
| | High Viscosity (Flowable Fluids) | ✓ | + | ✓ | ✓ | ✓ |
| | Erosion / Abrasive Fluids | High | + | + | ! | ✓ |
| Moderate | | + | + | ! | ✓ | ! |
| Low | | + | + | ✓ | + | ✓ |
| Corrosion | ✓ | ✓ | + | ✓ | + | |
| Installation | Permanent | + | + | ✓ | ✓ | ✓ |
| | Portable | + | + | + | + | + |
| | Containment / Prevention | ! | ! | + | ! | ! |
| | Flooded Suction | ✓ | + | ✓ | ✓ | ✓ |
| | Suction Lift | + | ✓ | ✓ | ✓ | ✓ |
| | Submerged | ✓ | ✓ | ! | ✓ | ! |
| Duty | Intermittent / On-Demand | + | + | + | + | + |
| | Continuous | ✓ | + | ✓ | ✓ | ✓ |

+ = Best Type ✓ = Suitable ! = Limitations ✗ = Not Recommended

Pump Performance

- Select Flow Rate (GPM)**
Example: 80 GPM
- Determine Discharge Head (PSI)**
Example: 45 PSI
- See Inlet Air Pressure (PSI)**
Example: 78 PSI
- See Air Consumption (SCFM)**
Example: 60 SCFM

Selection Tip: Size-Up

See the MTBF section below to learn the impact of sizing up your pump to increase energy savings and reduce wear on the pump to measurably reduce total cost of ownership

2" Curve Example: 80 GPM, 45 PSI = 60 SCFM.

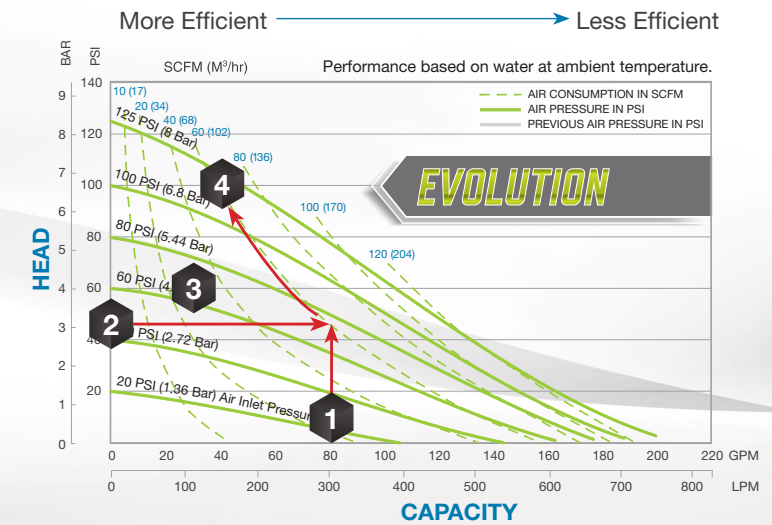

Sizing to Extend Mean Time Between Failures

Pumping requirements (flow & head) for most applications can be met by multiple sizes of pumps. Talk to SANDPIPER's application engineers to assist you with a size selection which best fits your total cost of ownership budget. An appropriately sized-up pump will lower the consolidated initial investment, repair, labor and energy costs. This **BEST PRACTICE** ensures desirable returns on the initial investment frequently measurable in weeks.

Experienced application engineers are available to help you determine the best fit pump size for your application. Call our factory or email: WRM.APPTECH.SP@IDEXCORP.COM

1½" Standard Duty
30 PSI, 80 GPM = 90 SCFM

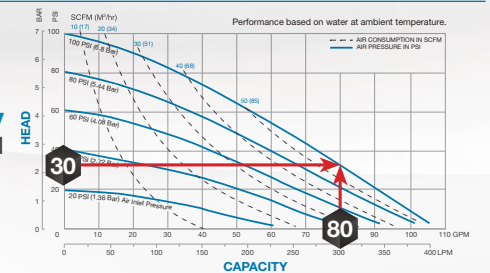

3" Standard Duty
30 PSI, 80 GPM = 38 SCFM

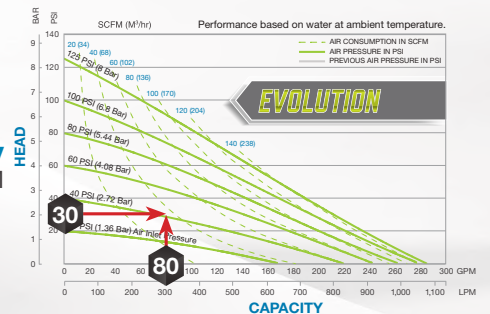

Additional Resources

Chemical Guide
Available through our mobile app (sandpiper.aoddpumpsonline.com) or online, this chemical compatibility guide will help you zero in on the pump that fits your process best.
CHEMGUIDE.SANDPIPERPUMP.COM

Technical Resources
Find further information on sizing and selection of SANDPIPER products at SANDPIPERPUMP.COM/TECH_RESOURCES

EXCLUSIVE PUMP CONFIGURATIONS

WITH THE BROADEST RANGE OF CONFIGURATIONS, SANDPIPER HAS A SOLUTION FOR YOUR PUMPING PROBLEM, WITH MORE WAYS THAN ONE



PG. 20

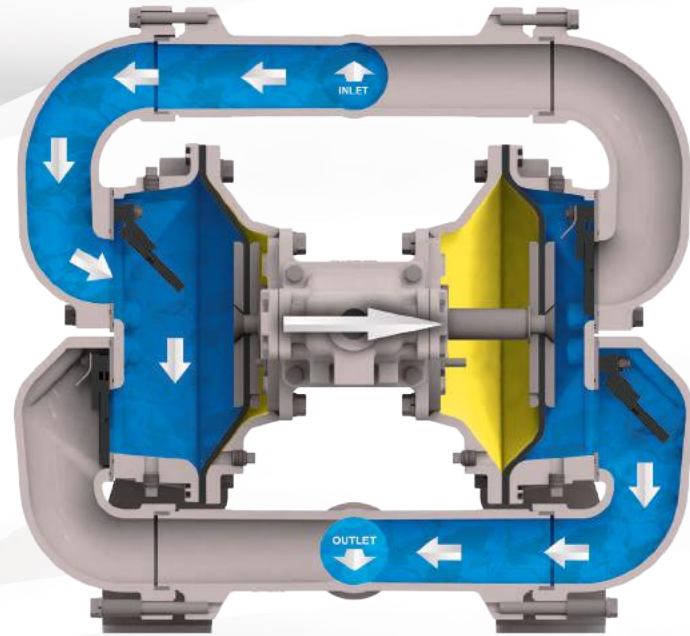

HEAVY DUTY FLAP VALVE

Unique features for this configuration include:

- Pumps up to line size solids
- Bottom discharge porting, discharges settling solids
- Superior suction lift of up to 24 ft.
- Easy access to serviceable components
- Thick manifold and chamber walls
- Diaphragm wear pads extend service life



PG. 28

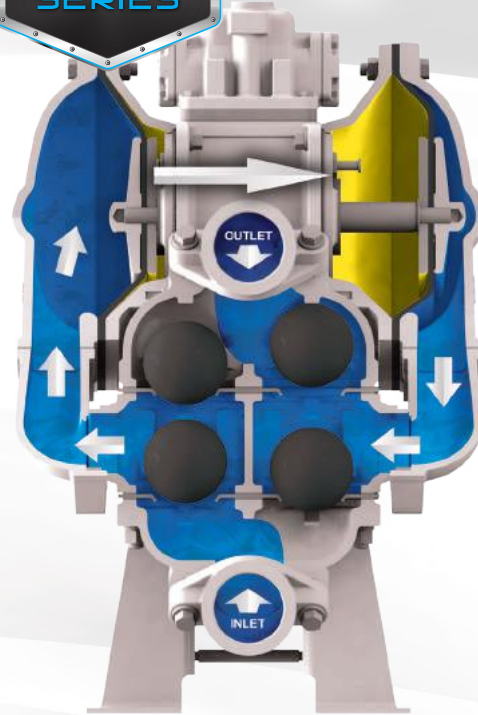

HEAVY DUTY BALL VALVE

Unique features for this configuration include:

- Down ported option, discharges settling solids
- Weighted check balls for handling viscous fluids
- Top ported option, discharges floating solids, suspended solids or entrained gases
- Side ported option for use in confined spaces
- Thick manifold and chamber walls
- Diaphragm wear pads extend service life



PG. 32

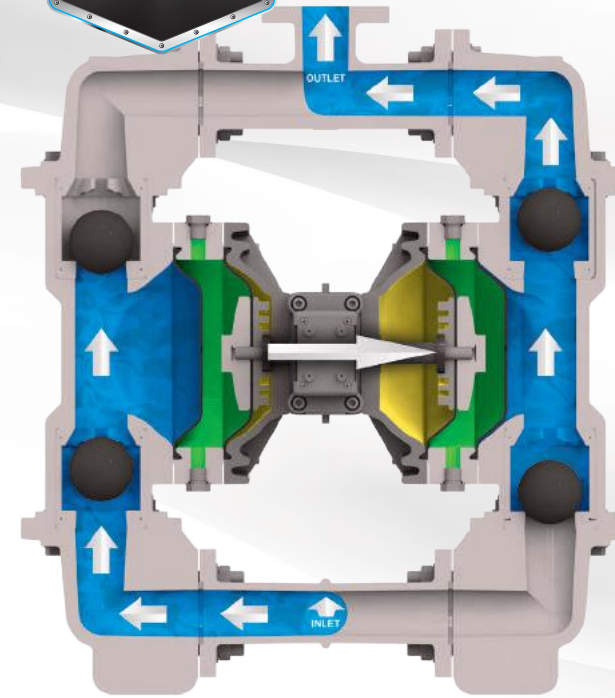

CONTAINMENT DUTY BALL VALVE

Unique features for this configuration include:

- Containment chamber with leak detection
- Hydraulically balanced / coupled pumping and driver diaphragm assemblies
- Solids range +.25" (6mm) to .71" (18mm)
- Dry primes up to 18' of water
- Free standing support base

PG. 36

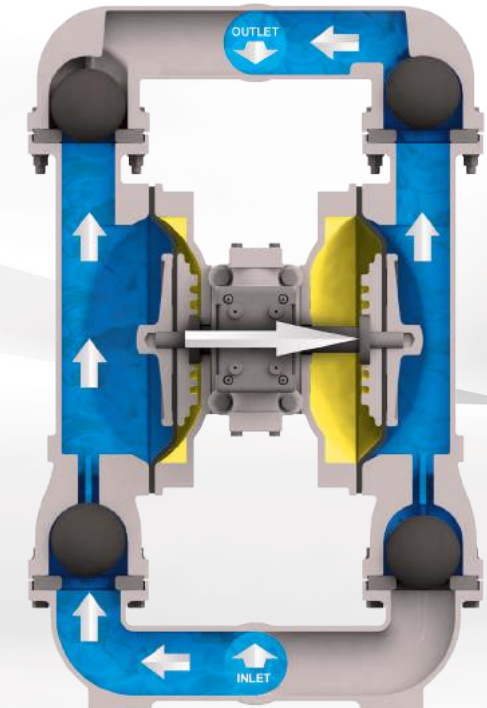

STANDARD DUTY BALL VALVE

Unique features for this configuration include:

- Solids range +.03" (1mm) to .71" (18mm)
- Dry primes up to 20' of water
- ESADS+ Air Distribution System



ALL SANDPIPER PUMPS feature the exclusive ESADS+Plus performance guaranteed, in-line serviceable, air valve system.

SCAN TO LEARN MORE
SANDPIPERPUMP.COM/ESADS



ALL SANDPIPER PUMPS come with a guaranteed diaphragm connecting rod.

HEAVY DUTY FLAP VALVE PUMPS

FOR FLUIDS CONTAINING UP TO LINE SIZE SOLIDS

HDF Pumps are recommended for abrasive slurries, suspended and non-suspended solids and line-size solids requirements. All SANDPIPER Heavy Duty Flap Valve Pumps are configured in bottom discharge porting arrangements and provide superior suction lift. HDF pumps are thick wall constructed of Sand Casted Aluminum, Cast Iron and Stainless Steel with elastomer, TPE (thermal plastic elastomers) and PTFE options in diaphragms and check valves. HDF pumps are enhanced with an extended wear package.

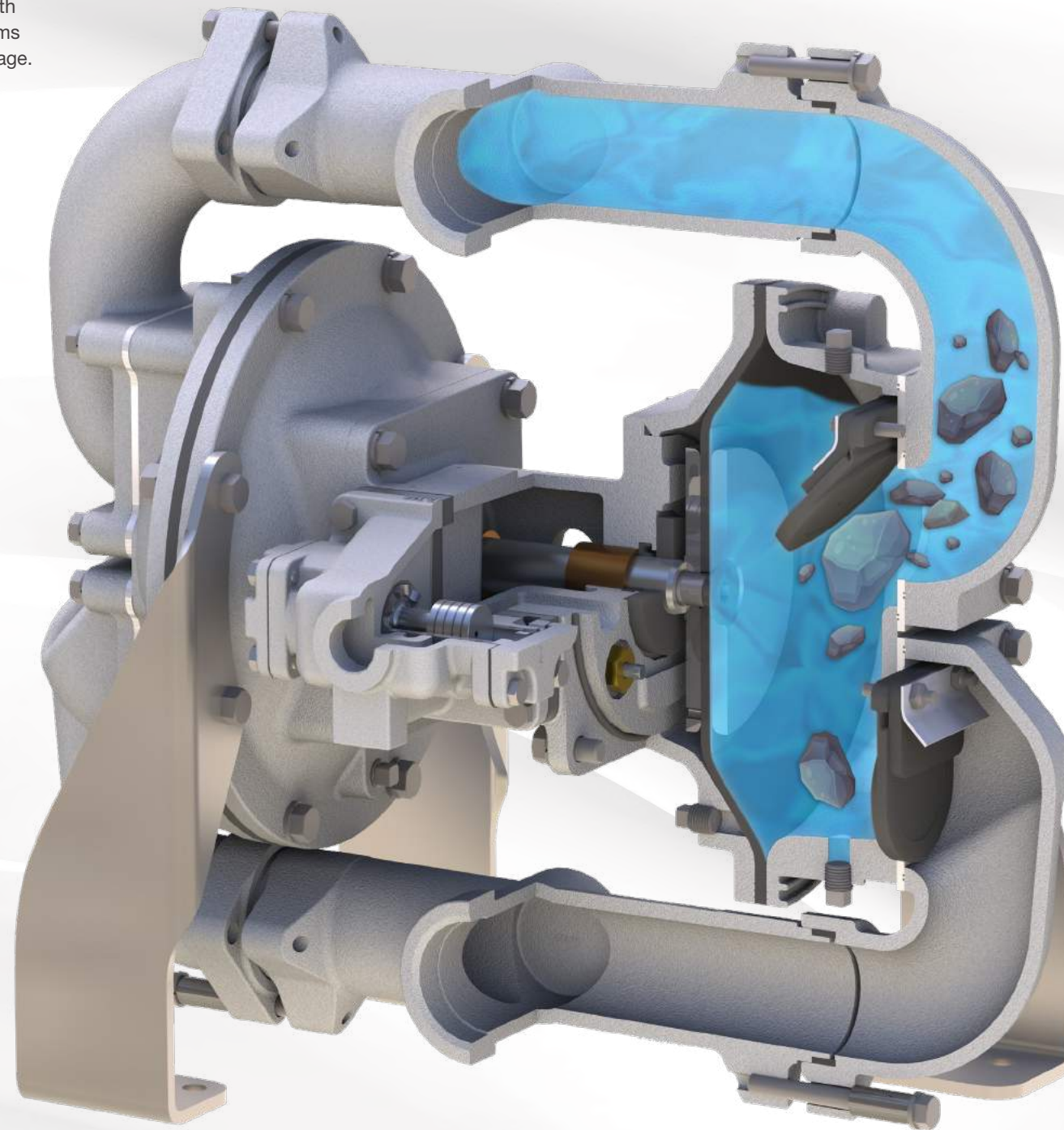

Durable Diaphragm Connecting Rods
Reliable and consistent diaphragm control

Lightweight & Portable
Weights range from 48 lbs (21 kg)

ESADS+Plus Air Valve
Externally Serviceable Air Distribution System

Bottom Discharge
For pumping out of tough areas

Flap Check Valves
Provide large solid abilities

All Bolted Construction
Durable and high pressure capable

Dynamic Manifold Connections
90° - 180° rotation options

Solids Range
+1" (25mm) to 3" (75mm)

Superior Dry Prime
Up to 24' (7m) of water

Certifications Available
CE Ex ATEX

| PUMP CHARACTERISTICS | | Metallic |
|-----------------------|----------------------------------|----------|
| Fluid Characteristics | Water | + |
| | Suspended Solids | ✓ |
| | Non-Suspended Solids | + |
| | Line Size Solids | + |
| | Sludge / Slurry | + |
| | High Viscosity (Flowable Fluids) | ✓ |
| | Erosion / Abrasive Fluids | High |
| Moderate | | + |
| Low | | + |
| Corrosion | ✓ | |
| Installation | Permanent | + |
| | Portable | + |
| | Containment / Prevention | ! |
| | Flooded Suction | ✓ |
| | Suction Lift | + |
| | Submerged | ✓ |
| Duty | Intermittent / On-Demand | + |
| | Continuous | ✓ |

+ = Best Type ✓ = Suitable ! = Limitations X = Not Recommended

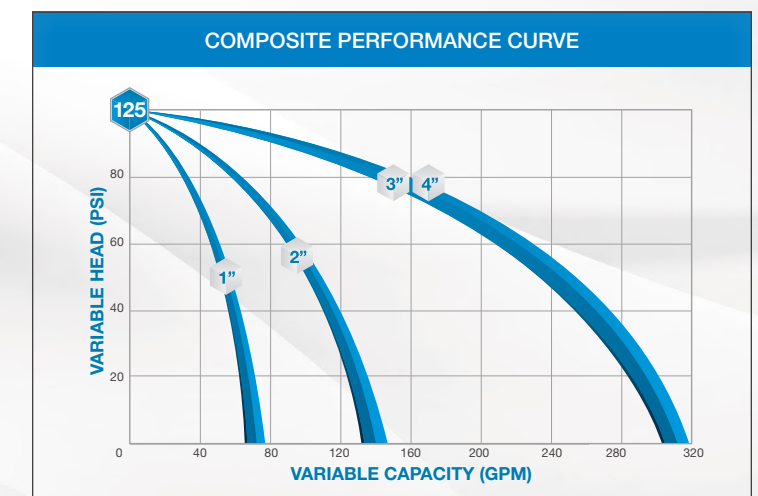

HEAVY DUTY FLAP VALVE PUMPS

PERFORMANCE & SPECIFICATIONS

1"
25mm

HDF1 Metallic Performance



- MAX FLOW**
• 70 GPM (265 LPM)
- PORTING**
• NPT / BSP
- AIR END**
• Aluminum
• Cast Iron
- WET END**
• Aluminum
• Stainless Steel
• Cast Iron

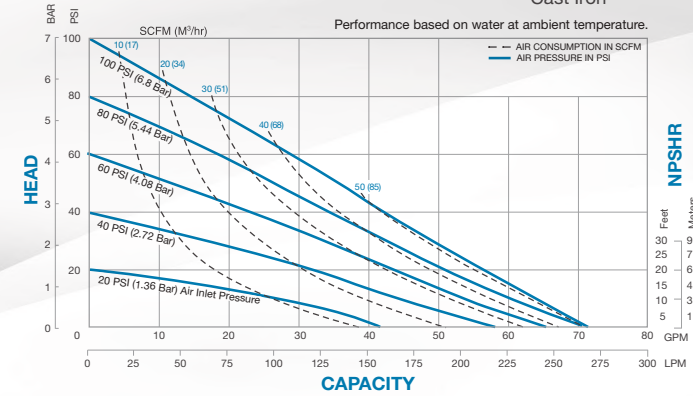

2"
50mm

HDF2 Metallic Performance



- MAX FLOW**
• 208 GPM (787 LPM)
- PORTING**
• NPT / BSP
- AIR END**
• Aluminum
• Cast Iron
- WET END**
• Aluminum
• Stainless Steel
• Cast Iron

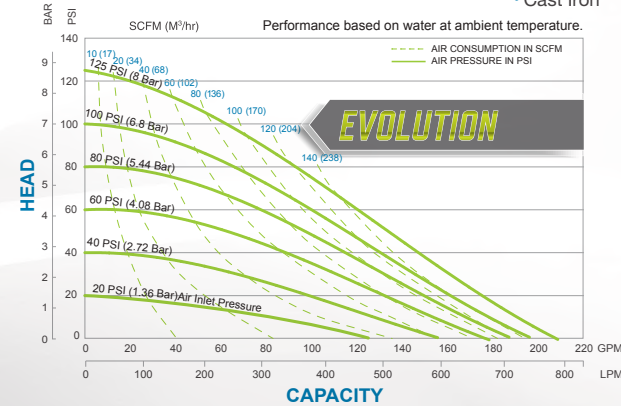

3-4"
75-102mm

HDF3-A / 4-A Metallic Performance



- MAX FLOW**
• 310 GPM (1,173 LPM)
- PORTING**
• ANSI Flange
- AIR END**
• Aluminum
- WET END**
• Aluminum

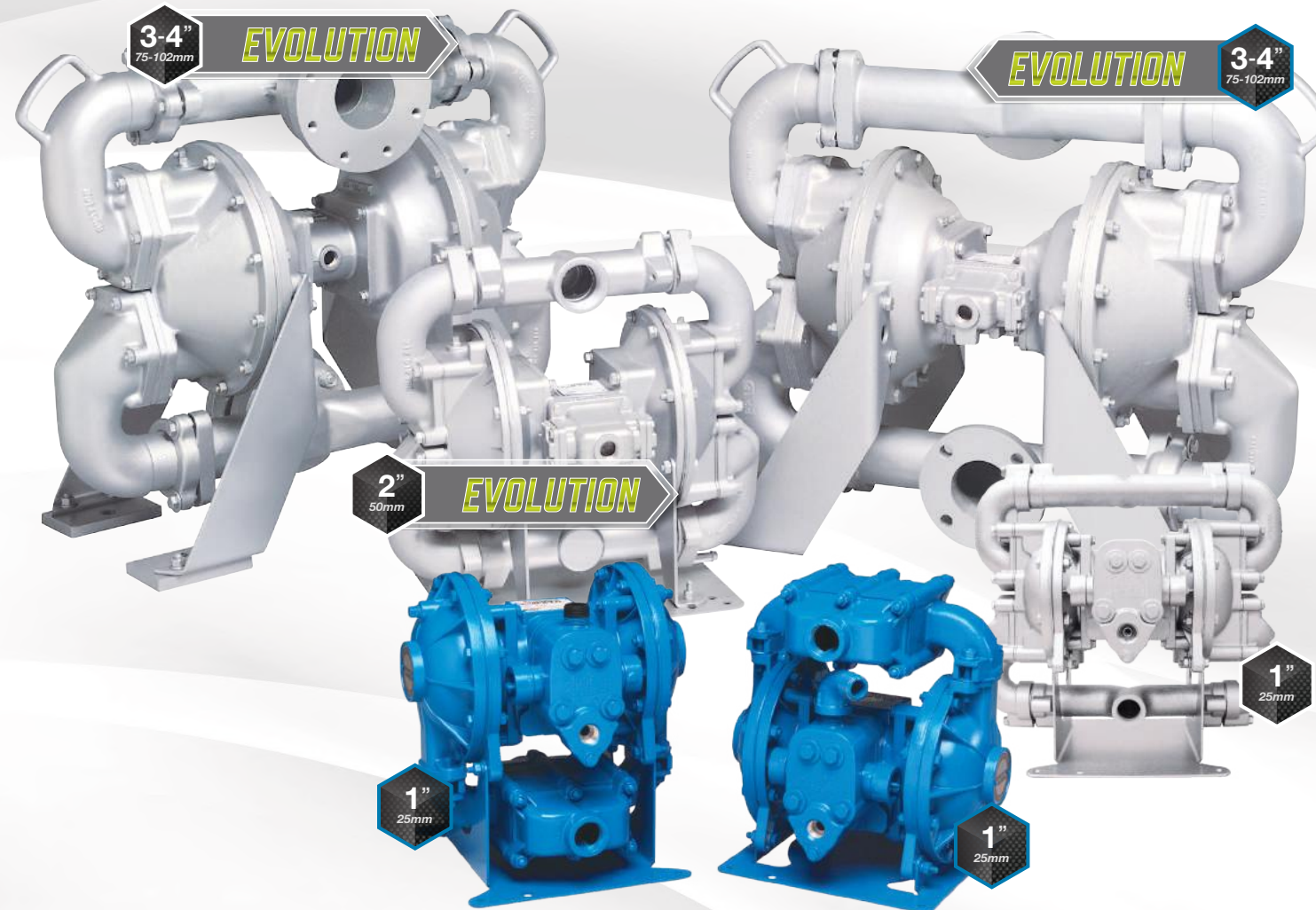
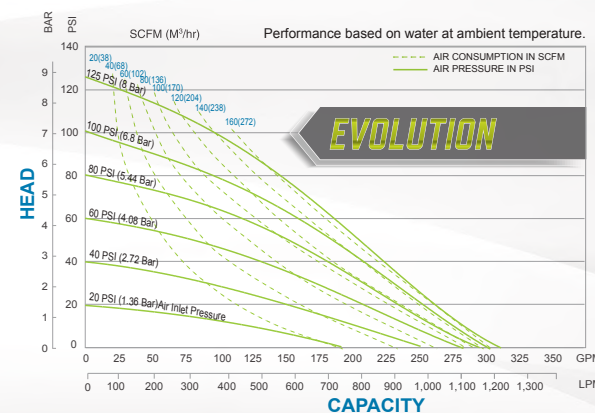

Bottom Discharge

Top Discharge

3-4"
75-102mm

HDF3-M / 4-M Metallic Performance



- MAX FLOW**
• 303 GPM (1,147 LPM)
- PORTING**
• ANSI Flange
- AIR END**
• Cast Iron
- WET END**
• Cast Iron

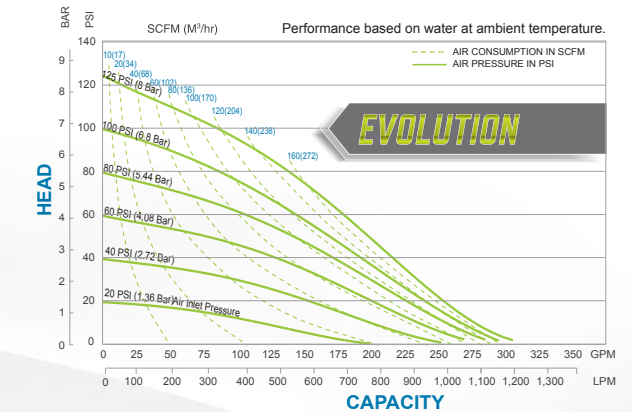

1"
25mm

SA1 Metallic Performance



- MAX FLOW**
• 42 GPM (159 LPM)
- PORTING**
• NPT / BSP
- AIR END**
• Aluminum
• Cast Iron
- WET END**
• Aluminum
• Stainless Steel

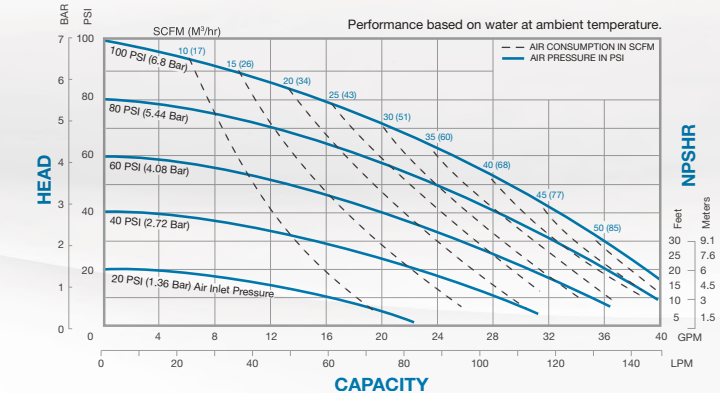

SPECIFICATIONS

| PUMP MODELS | A | B | C | D | E | Connection Style | Pipe Size | Displacement Per Stroke | Max Flow Per Minute | Max Solids Handling | Max Discharge Pressure |
|-------------|-------------|-------------|-------------|---------------------------|--------------------------|------------------|-----------|-------------------------|---------------------|---------------------|------------------------|
| | Height | Width | Depth | Bottom of Base to Suction | Center Line of Discharge | | | | | | |
| | inches (mm) | inches (mm) | inches (mm) | inches (mm) | inches (mm) | | inch (mm) | gal (liter) | gal (liter) | inch (mm) | psi (bar) |
| HDF1 | 15.69 (398) | 16.75 (425) | 10.81 (274) | 14.06 (356) | 2.56 (65) | 1" NPT / BSP | 1 (25) | .10 (.38) | 70 (265) | 1 (25) | 125 (8.6) |
| HDF2 | 20.31 (516) | 21.75 (552) | 13.63 (346) | 17.69 (449) | 2.56 (65) | 2" NPT only | 2 (50) | .47 (1.78) | 208 (787) | 2 (50) | 125 (8.6) |
| HDF3-A | 29.5 (749) | 36.56 (929) | 16.25 (413) | 25.75 (654) | 4.25 (108) | 3" 125# ANSI | 3 (75) | 1.60 (6.06) | 310 (1173) | 3 (75) | 125 (8.6) |
| HDF3-M | 30.25 (768) | 32.31 (821) | 16.19 (411) | 26.5 (673) | 5 (127) | 3" 125# ANSI | 3 (75) | 1.15 (4.35) | 303 (1147) | 3 (75) | 125 (8.6) |
| HDF4-A | 31 (787) | 36.56 (929) | 21.25 (540) | 26.5 (673) | 5 (127) | 4" 125# ANSI | 4 (102) | 1.60 (6.06) | 310 (1173) | 3 (75) | 125 (8.6) |
| HDF4-M | 31 (787) | 32.31 (821) | 16.19 (411) | 26.5 (673) | 5 (127) | 4" 125# ANSI | 4 (102) | 1.15 (4.35) | 303 (1147) | 3 (75) | 125 (8.6) |
| SA1 | 12.38 (314) | 11.36 (288) | 11.26 (286) | 10.69 (271) | 10.69 (271) | 1" NPT / BSP | 1 (25) | .09 (.34) | 42 (159) | 1 (25) | 125 (8.6) |

Dimensional Tolerance: ±1/8" (± 3mm) • See service manual for complete specifications.

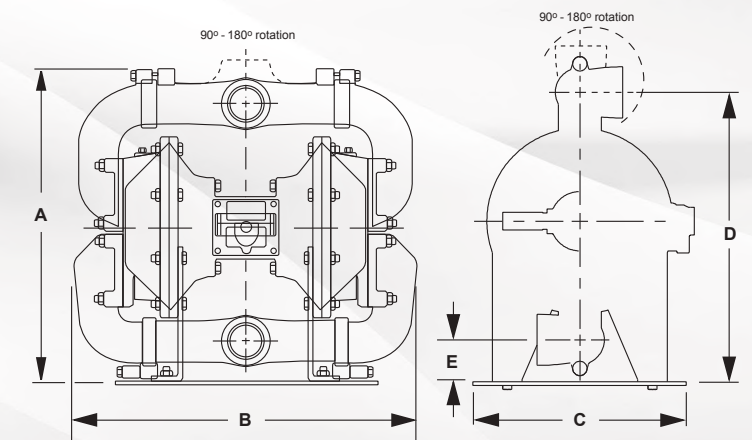

2" NON-METALLIC FLAP VALVE PUMP

YOUR MINING, GENERAL INDUSTRIAL AND CHEMICAL SOLUTION

The robust, yet lightweight design allows for ease of maintenance and movement, and is ideal for handling solids and corrosive fluids. This unique pump has been engineered to fully function in any position, includes lifting handles and hanging points, and has durable mounting feet. This is an ideal solution for numerous applications.

Lightweight & Durable
The non-metallic, lightweight design makes it easily portable at 53 lbs (24 kg)

Reliability Guarantee
Strongest diaphragm connecting rod in the industry is guaranteed to not bend or yield in operation

Rugged Design
Stainless steel seats prevent abrasion when pumping solids laden fluids

Optimum Solids Handling
Hinge pads exert positive pressure on the flaps, allowing the pump to operate in virtually any position; they help deliver superior suction lift and flow rates

Long Life
A proven diaphragm design in conjunction with exclusive wear pads reduce plate abrasion, delivering extended life

Purpose Built Base
The threaded version features stainless steel mounting feet and the flanged version features Polypropylene mounting feet

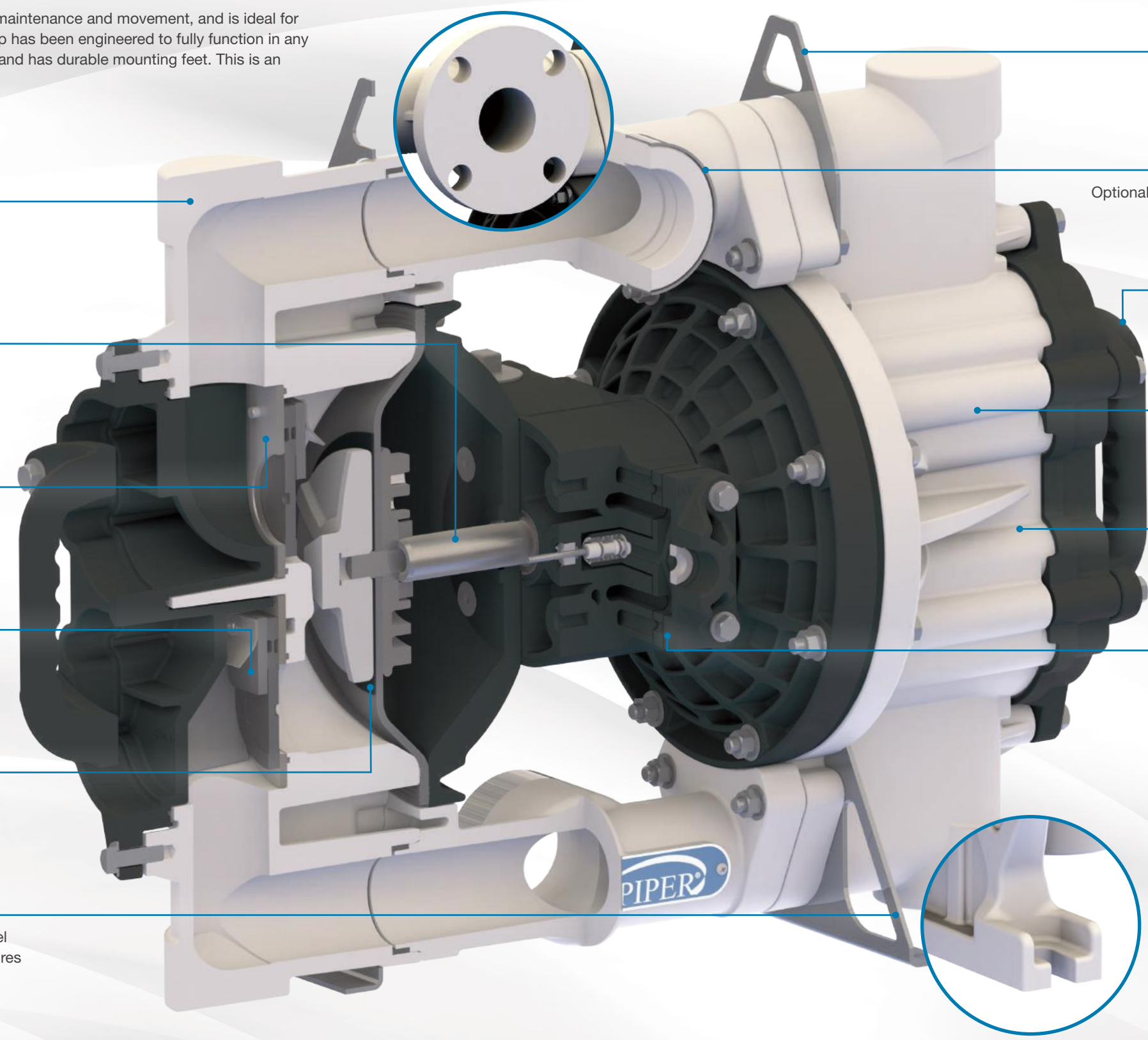

Industrial Mounting Capabilities
Addition of stainless steel hanging points located on the manifold allow for multiple mounting options

Strong Manifold Connections
Optional flanged or threaded connection for additional flexibility: Stainless steel reinforcing rings help protect the threaded manifold connections from being damaged

Ergonomic Handle
Lifting handles come standard, allowing for easy pump transport; handles can be rotated 90 degrees for proper ergonomics, depending on desired use

Unsurpassed Performance
Industry leading flow rates, suction lift, air efficiency and displacement per stroke

Versatile Design
This pump will function in any position, including uneven surfaces

Simple Maintenance
With our signature ESADS+Plus (Externally Serviceable Air Distribution System) air valve design and externally serviceable flap valve modules, in-field service is quick and easy, saving you from unnecessary downtime



Visit SANDPIPERPUMP.COM/ESADSVideos to see how easy the ESADS air valve makes maintaining the 2" Non-Metallic Flap Valve.

HEAVY DUTY NON-METALLIC FLAP VALVE PUMP

PERFORMANCE & SPECIFICATIONS

2"
50mm

HD20F Non-Metallic Performance



- MAX FLOW**
• 150 GPM (567 LPM)
- PORTING**
• NPT / BSPT
- AIR END**
• Polypropylene
- WET END**
• Polypropylene
• Stainless Steel (seats only)

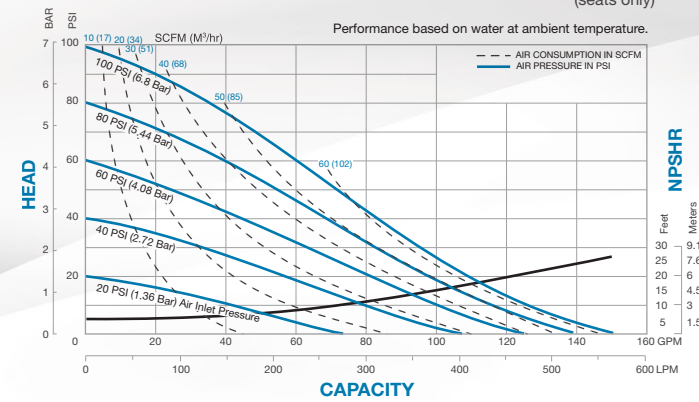

Ease of Valve Maintenance

To help increase productivity and reduce downtime, the 2" Non-Metallic Flap Valve Pump was engineered with ease of maintenance in mind.

QUICK ACCESS TO SERVICEABLE COMPONENTS

1. Remove Clean-Out Cap

By simply removing six bolts securing the clean-out cap in place, it allows access to clear simple clogs without disassembling the entire pump.

2. Modular Check Valve Access

With the clean-out cap removed, the flap valves can be inspected and / or replaced as needed. Four bolts hold the modular flap valves in place for quick maintenance and repair.

3. ESADS+Plus

Proven air distribution system allows for maintenance and / or repair of both pilot valve and air valve components without removing the pump from service.

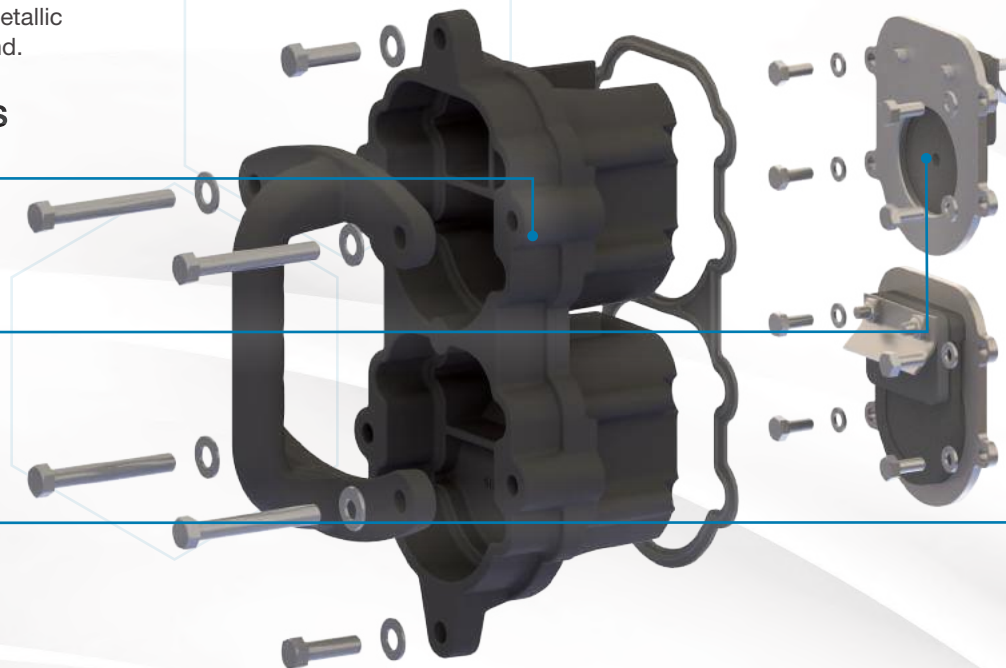

Visit SANDPIPERPUMP.COM/ESADSVIDEO to see how easy the ESADS air valve makes maintaining the 2" Non-Metallic Flap Valve.

| SPECIFICATIONS | | | | | | | | | | | |
|----------------|-------------|------------|-------------|-------------------------------------------|-----------|------------------|-----------|-------------------------|---------------------|---------------------|------------------------|
| PUMP MODEL | A | B | C | D | E | Connection Style | Pipe Size | Displacement Per Stroke | Max Flow Per Minute | Max Solids Handling | Max Discharge Pressure |
| | Height | Width | Depth | Bottom of Base to Center Line of: Suction | Discharge | | inch (mm) | gal (liter) | gal (liter) | inch (mm) | psi (bar) |
| HD20F | 20.89 (531) | 29.7 (754) | 12.65 (321) | 17.56 (446) | 2 (50) | 2" NPT / BSPT | 2 (50) | .50 (1.9) | 150 (567) | 1.8 (46) | 100 (7) |

Dimensional Tolerance: ±1/8" (± 3mm) • See service manual for complete specifications.

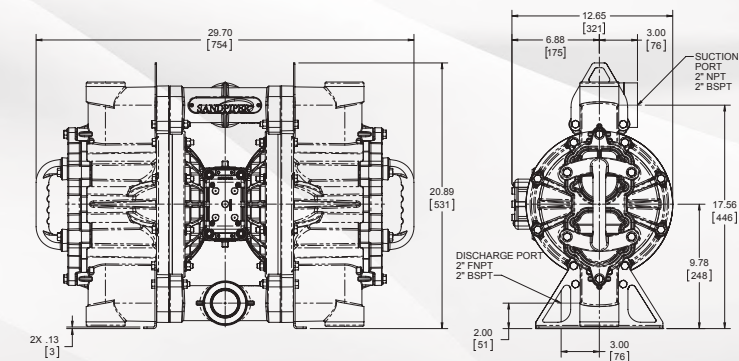

HEAVY DUTY BALL VALVE PUMPS

FOR FLUIDS CONTAINING SETTLING, SUSPENDED & FLOATING SOLIDS

HDB Metallic Pumps are ideal for thin to highly viscous and small solids-laden fluids, while providing excellent suction lift capability and exclusive variable porting options (side, top, bottom and dual). HDB pumps are thick wall constructed of Sand Casted Aluminum, Cast Iron, Stainless Steel or Alloy C with elastomer, TPE (thermal plastic elastomers) and PTFE options in diaphragms and check valves. HDB pumps are enhanced with an extended wear package.



Top Porting Position

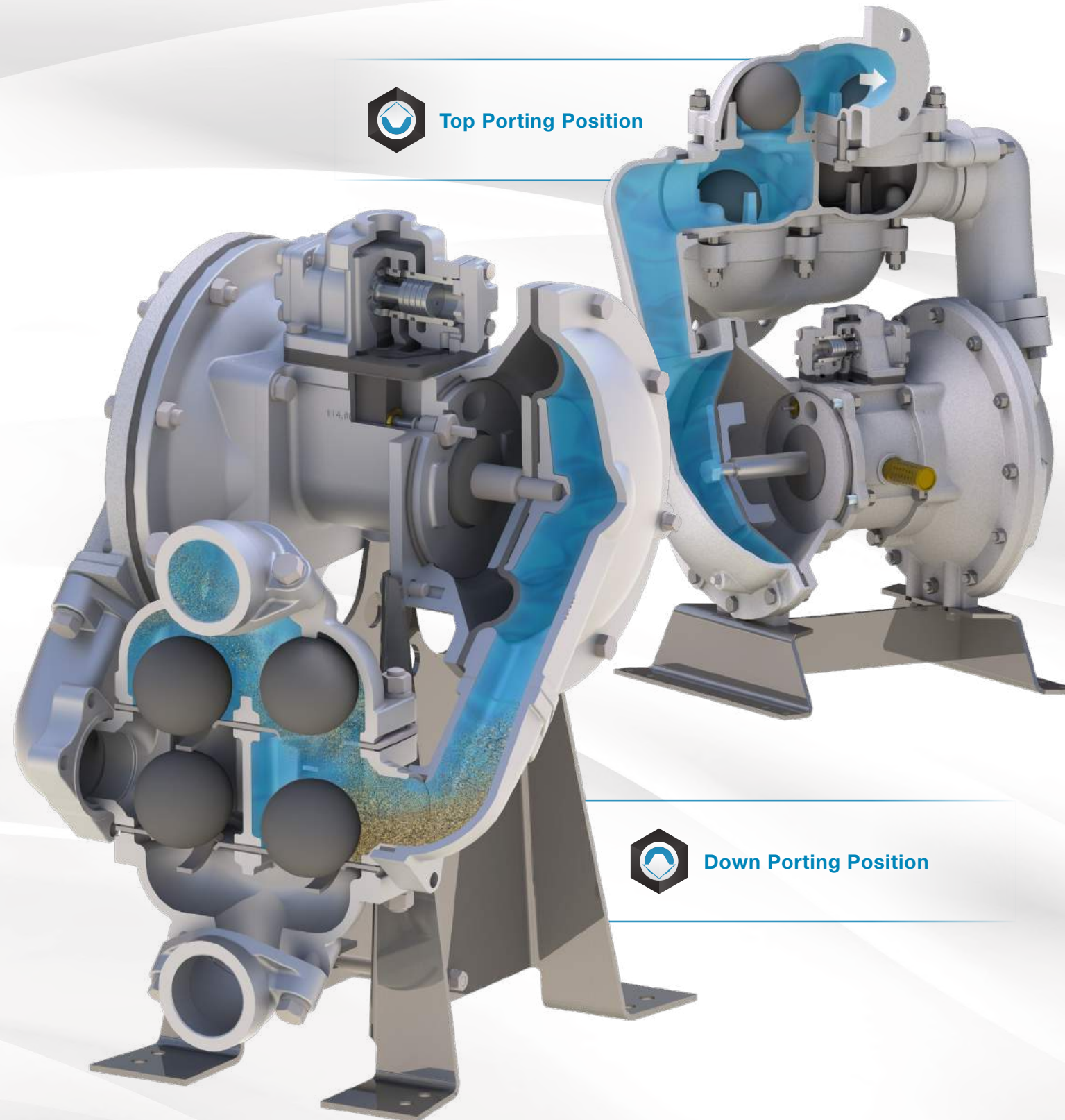

Down Porting Position



Bottom or Top Porting Positions

Greater process connection flexibility



All Bolted Construction

Durable and high pressure capable



Lightweight & Portable

Weights as low as 31 lbs (14 kg)



Ball Check Valves

Provide powerful, high flow pumping



Diaphragm Connecting Rods

Reliable and consistent diaphragm control



ESADS+Plus Air Valve

Externally Serviceable Air Distribution System



Dynamic Manifold Connections

Can be vertically or horizontally mounted



Certifications Available



| PUMP CHARACTERISTICS | | Metallic |
|-----------------------|----------------------------------|----------|
| Fluid Characteristics | Water | + |
| | Suspended Solids | + |
| | Non-Suspended Solids | + |
| | Line Size Solids | X |
| | Sludge / Slurry | + |
| | High Viscosity (Flowable Fluids) | + |
| | Erosion / Abrasive Fluids | High |
| Moderate | | + |
| Low | | + |
| Corrosion | ✓ | |
| Installation | Permanent | + |
| | Portable | ✓ |
| | Containment / Prevention | ! |
| | Flooded Suction | + |
| | Suction Lift | ✓ |
| | Submerged | ✓ |
| Duty | Intermittent / On-Demand | + |
| | Continuous | + |

+ = Best Type ✓ = Suitable ! = Limitations X = Not Recommended

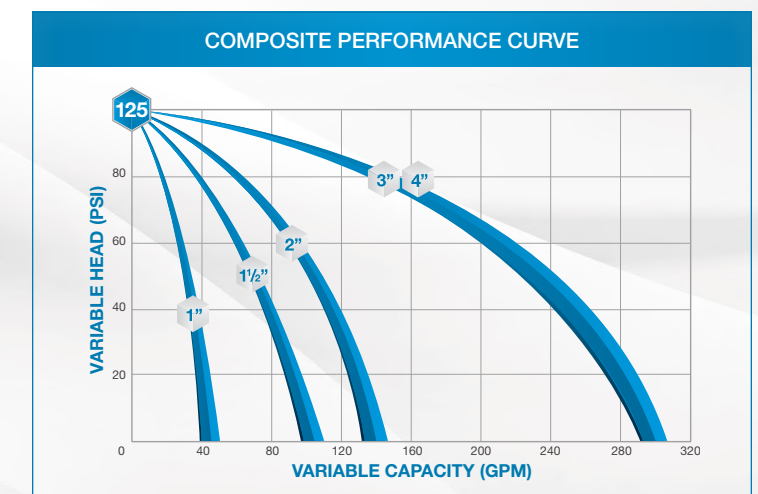

HEAVY DUTY BALL VALVE PUMPS

PERFORMANCE & SPECIFICATIONS

1 1/2"
38mm

HDB1 1/2 Metallic Performance



- MAX FLOW**
• 122 GPM (462 LPM)
- PORTING**
• NPT / BSP
• Available in side port only
- AIR END**
• Aluminum
• Cast Iron
- WET END**
• Aluminum
• Stainless Steel
• Alloy C
• Cast Iron

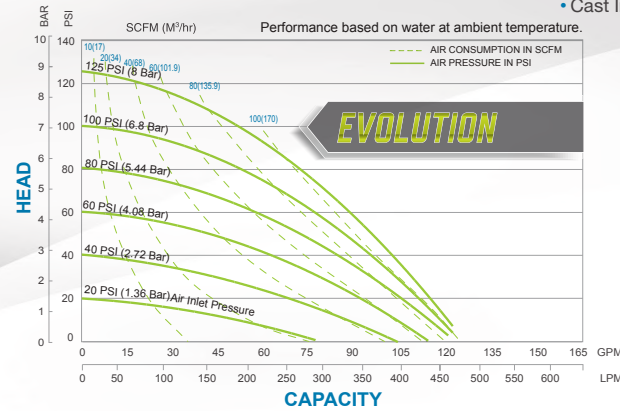

2"
50mm

HDB2 Metallic Performance



- MAX FLOW**
• 135 GPM (511 LPM)
- PORTING**
• NPT
- AIR END**
• Aluminum
• Cast Iron
- WET END**
• Aluminum
• Stainless Steel
• Alloy C
• Cast Iron

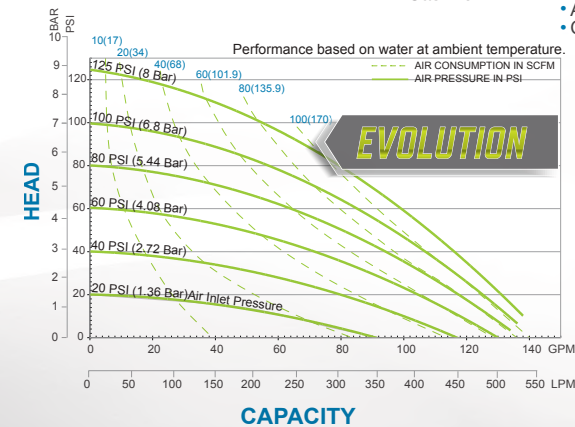

3-4"
75-102mm

HDB3 / HDB4 Metallic Performance



- MAX FLOW**
• 300 GPM (1,136 LPM)
- PORTING**
• ANSI Flange
- AIR END**
• Cast Iron
- WET END**
• Stainless Steel
• Cast Iron

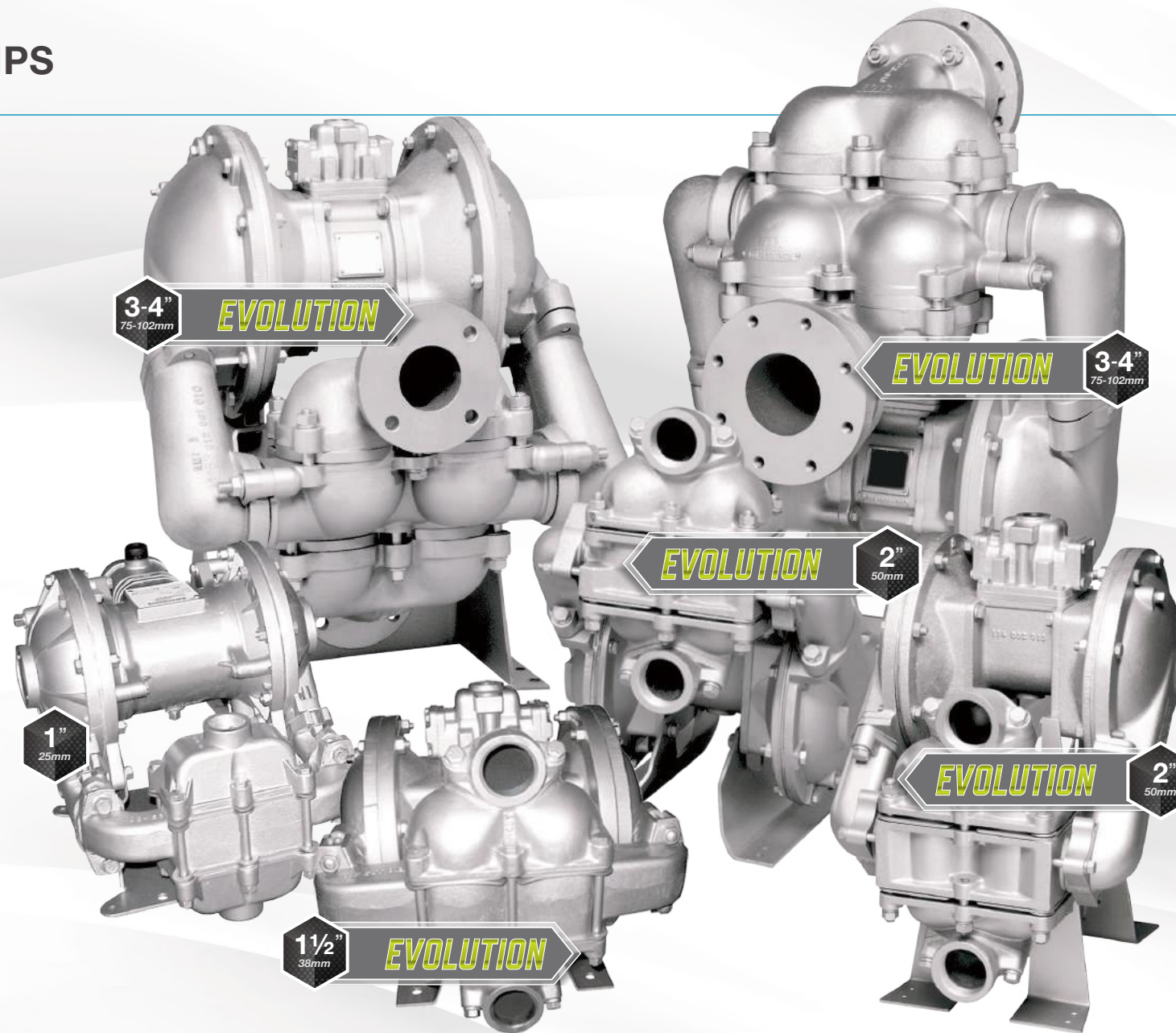
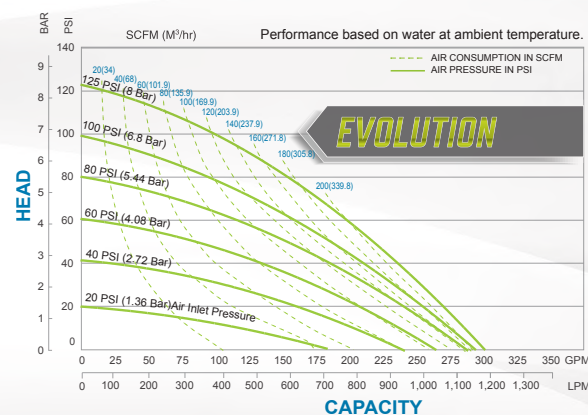

1"
25mm

SB1 / SB25 Metallic Performance



- MAX FLOW**
• 42 GPM (159 LPM)
- PORTING**
• NPT / BSP
- AIR END**
• Aluminum
• Cast Iron
- WET END**
• Aluminum
• Stainless Steel
• Alloy C

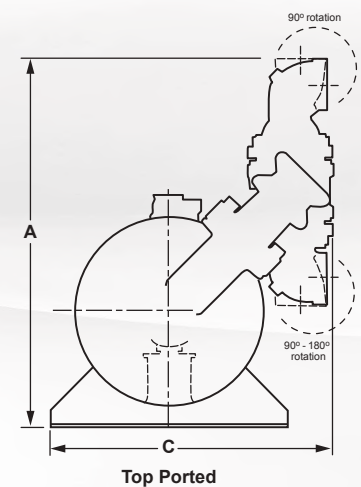
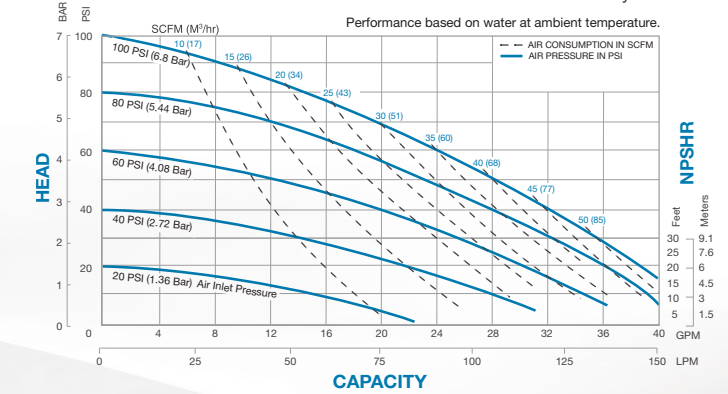

| PUMP MODELS | A | B | C | D | | Connection Style | Pipe Size | Displacement Per Stroke | Max Flow Per Minute | Max Solids Handling | Max Discharge Pressure |
|--------------|-------------|-------------|-------------|-------------------------------------------|-------------|------------------|-----------|-------------------------|---------------------|---------------------|------------------------|
| | Height | Width | Depth | Bottom of Base to Center Line of: Suction | Discharge | | | | | | |
| SB1 / SB25 | 14.44 (367) | 11.75 (298) | 13.28 (337) | 5.25 (133) | 13 (330) | 1" NPT/BSP | 1 (25) | .09 (.34) | 42 (159) | .25 (6) | 125 (8.6) |
| SB1 TOP | 13.5 (342) | 11.75 (298) | 14.88 (378) | 5.62 (142) | 13.5 (342) | 1" NPT/BSP | 1 (25) | .09 (.34) | 42 (159) | .25 (6) | 125 (8.6) |
| SB1 BOTTOM | 13.69 (347) | 11.75 (298) | 14.88 (378) | 2.22 (21) | 8.44 (214) | 1" NPT/BSP | 1 (25) | .09 (.34) | 42 (159) | .25 (6) | 125 (8.6) |
| HDB1 1/2 TOP | 19.22 (488) | 15.5 (419) | 17 (432) | 8.14 (207) | 18.08 (459) | 1 1/2" NPT/BSP | 1.5 (38) | .37 (1.4) | 122 (462) | .25 (6) | 125 (8.6) |
| HDB2 TOP | 22.19 (564) | 15.5 (394) | 16.81 (427) | 9.12 (232) | 20.88 (530) | 2" NPT | 2 (50) | .46 (1.7) | 135 (511) | .38 (9) | 125 (8.6) |
| HDB2 BOTTOM | 23.25 (591) | 15.5 (394) | 16.81 (427) | 3.44 (87) | 15.19 (386) | 2" NPT | 2 (50) | .46 (1.7) | 135 (511) | .38 (9) | 125 (8.6) |
| HDB3 TOP | 37.13 (943) | 26 (661) | 20.75 (527) | 20 (509) | 33.33 (848) | 3" 125# ANSI | 3 (75) | 2.0 (7.6) | 300 (1136) | .87 (22) | 125 (8.6) |
| HDB3 BOTTOM | 31.25 (794) | 26 (661) | 24.62 (625) | 5.75 (146) | 19.33 (492) | 3" 125# ANSI | 3 (75) | 2.0 (7.6) | 300 (1136) | .87 (22) | 125 (8.6) |
| HDB4 TOP | 37.88 (962) | 26 (661) | 23.75 (603) | 20 (509) | 33.33 (848) | 4" 125# ANSI | 4 (102) | 2.0 (7.6) | 300 (1136) | .87 (22) | 125 (8.6) |
| HDB4 BOTTOM | 31.25 (793) | 26 (661) | 27.5 (699) | 5.75 (146) | 19.33 (492) | 4" 125# ANSI | 4 (102) | 2.0 (7.6) | 300 (1136) | .87 (22) | 125 (8.6) |

Dimensional Tolerance: ±1/8" (± 3mm) • See service manual for complete specifications.

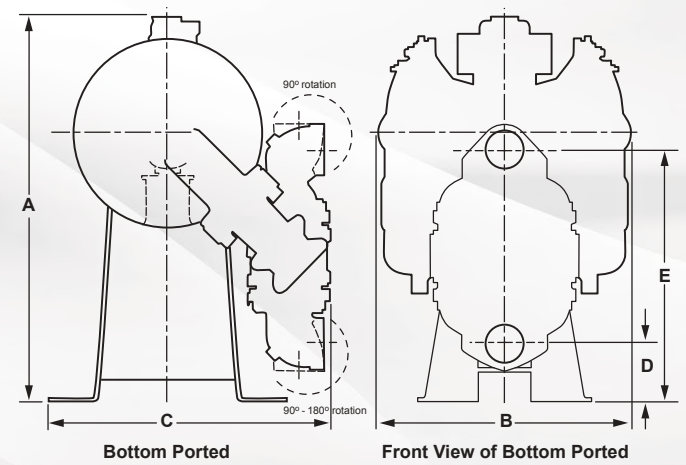





CONTAINMENT DUTY BALL VALVE PUMPS

THE ONLY COMPLETE LINE OF AODD PUMPS FEATURING SUPERIOR FLUID CONTAINMENT; PROTECTING YOUR PEOPLE, ENVIRONMENT, AND PUMP

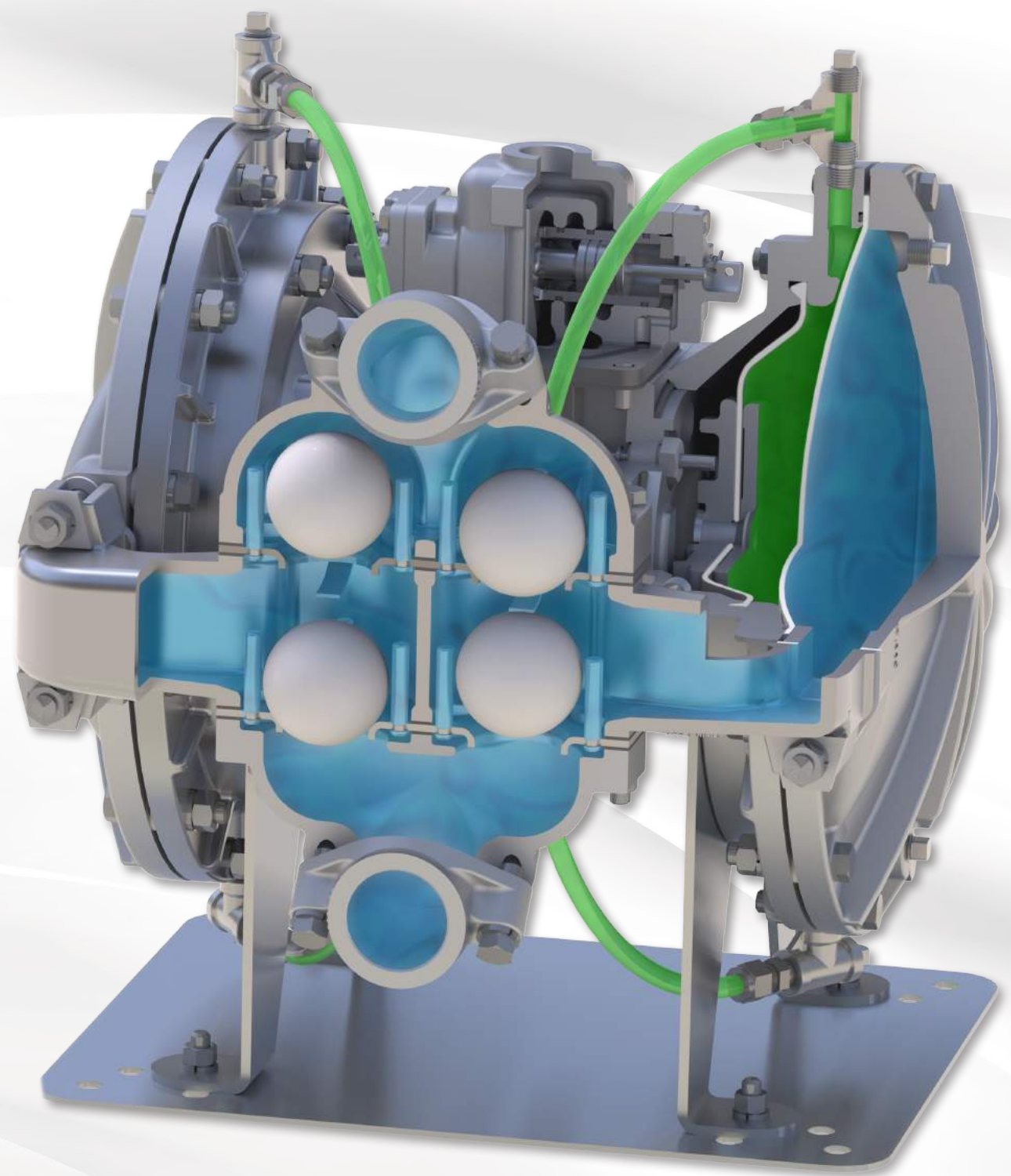
Containment Duty Metallic and Non-Metallic Pumps are ideal for highly corrosive and hazardous chemical fluid requirements. All containment duty pumps are exclusively designed with containment chambers, hydraulically balanced/coupled pumping diaphragm and driver diaphragm assemblies. All containment chambers are designed to accommodate visual, mechanical and low voltage leak detection devices. CD pumps are constructed of Aluminum, Cast Iron, Stainless Steel, Alloy C, Polypropylene and PVDF with TPE (thermal plastic elastomers), PTFE options in diaphragms and check valves.



-  **All Bolted Construction**
Durable and high pressure capable
-  **Top Discharge**
For pumping out of tough areas
-  **Diaphragm Connecting Rods**
Reliable and consistent diaphragm control
-  **Ball Check Valves**
Provides powerful, high flow pumping
-  **ESADS+Plus Air Valve**
Externally Serviceable Air Distribution System
-  **Dynamic Manifold Connections**
90° - 180° rotation options
-  **Certifications Available**
 

| PUMP CHARACTERISTICS | | Non-Metallic |
|-----------------------|----------------------------------|--------------|
| Fluid Characteristics | Water | + |
| | Suspended Solids | ✓ |
| | Non-Suspended Solids | X |
| | Line Size Solids | X |
| | Sludge / Slurry | ! |
| | High Viscosity (Flowable Fluids) | ✓ |
| | Erosion / Abrasive Fluids | High |
| Moderate | | ! |
| Low | | ✓ |
| Corrosion | + | |
| Installation | Permanent | ✓ |
| | Portable | + |
| | Containment / Prevention | + |
| | Flooded Suction | ✓ |
| | Suction Lift | ✓ |
| | Submerged | ! |
| Duty | Intermittent / On-Demand | + |
| | Continuous | ✓ |

+ = Best Type ✓ = Suitable ! = Limitations X = Not Recommended

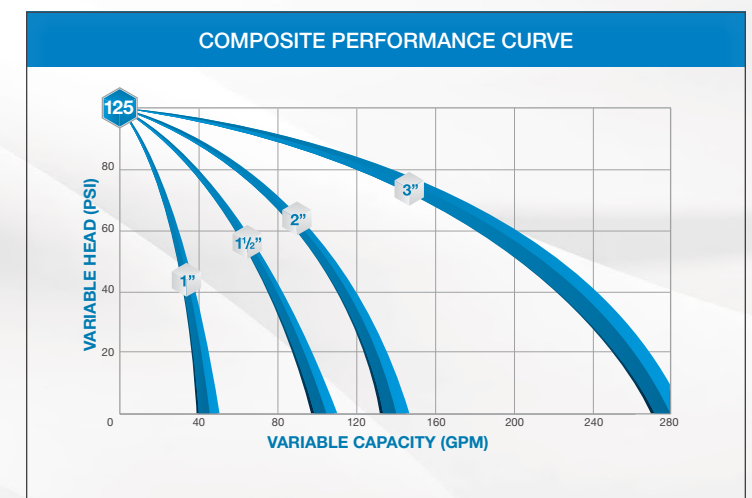

CONTAINMENT DUTY BALL VALVE PUMPS

PERFORMANCE & SPECIFICATIONS

1"
25mm

ST1 / ST25 Metallic Performance



- MAX FLOW**
• 42 GPM (159 LPM)
- PORTING**
• NPT / BSP
- AIR END**
• HDPE*
• Aluminum
- WET END**
• Aluminum
• Stainless Steel
• Alloy C

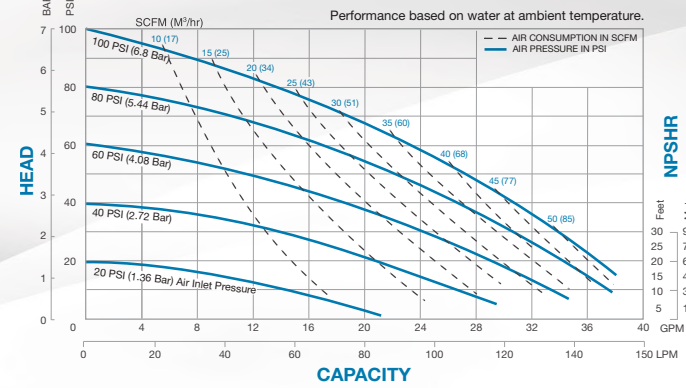

1 1/2"
38mm

ST1 1/2 / ST40 Metallic Performance



- MAX FLOW**
• 106 GPM (401 LPM)
- PORTING**
• NPT / BSP
- AIR END**
• Cast Iron
• Aluminum
- WET END**
• Aluminum
• Stainless Steel
• Alloy C

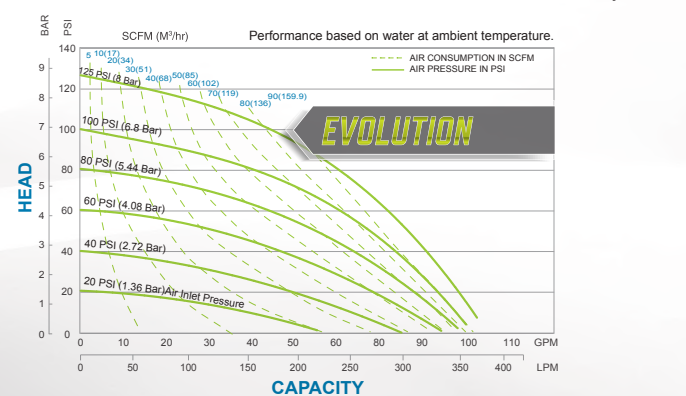

1"
25mm

S1F Non-Metallic Performance



- MAX FLOW**
• 53 GPM (200 LPM)
- PORTING**
• ANSI Flange
• DIN Flange
- AIR END**
• Polypropylene
- WET END**
• Polypropylene
• PVDF*

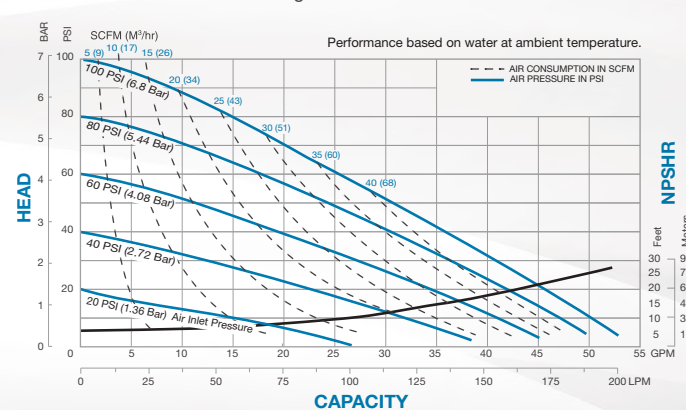

1 1/2"
38mm

S15 Non-Metallic Performance



- MAX FLOW**
• 100 GPM (378 LPM)
- PORTING**
• ANSI Flange
• DIN Flange
- AIR END**
• Polypropylene
- WET END**
• PVDF
• Polypropylene

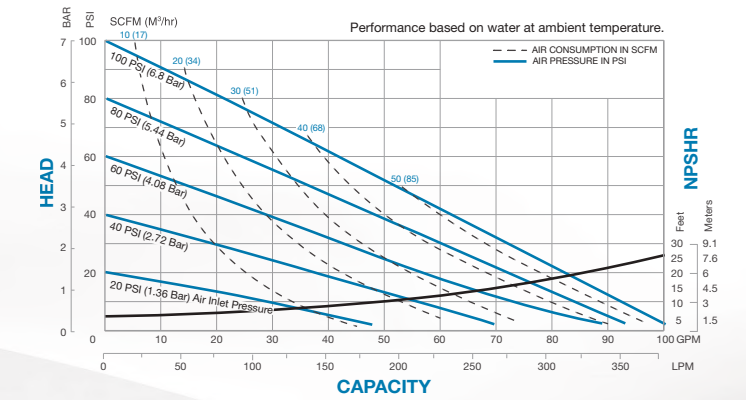

2"
50mm

S20 Non-Metallic Performance



- MAX FLOW**
• 160 GPM (605 LPM)
- PORTING**
• Universal Flange
- AIR END**
• Polypropylene
- WET END**
• Polypropylene
• PVDF

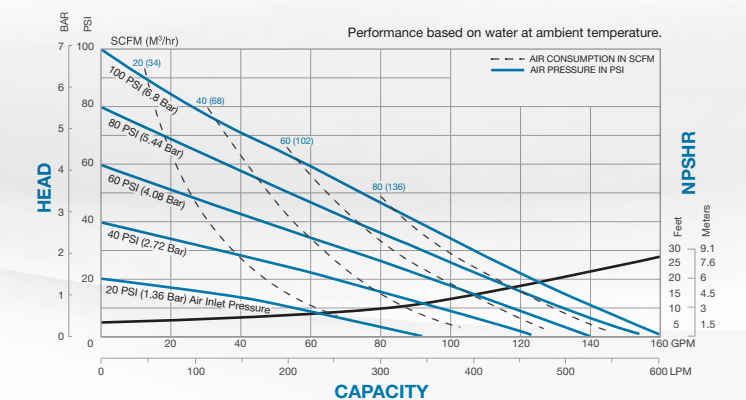

3"
75mm

S30 Non-Metallic Performance



- MAX FLOW**
• 280 GPM (1,061 LPM)
- PORTING**
• ANSI Flange
• DIN Flange
- AIR END**
• Glass Filled Polypropylene
- WET END**
• Polypropylene
• PVDF

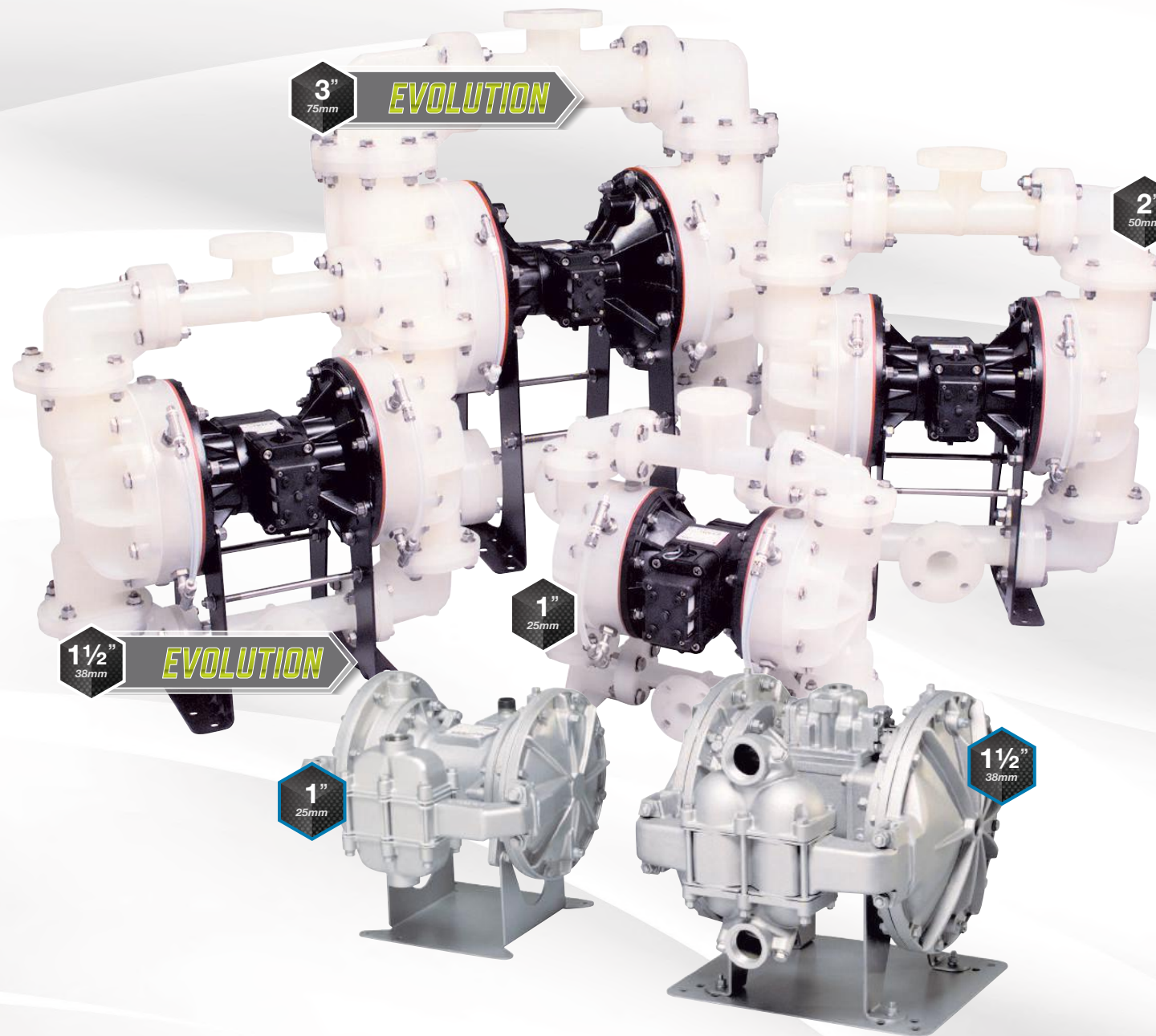
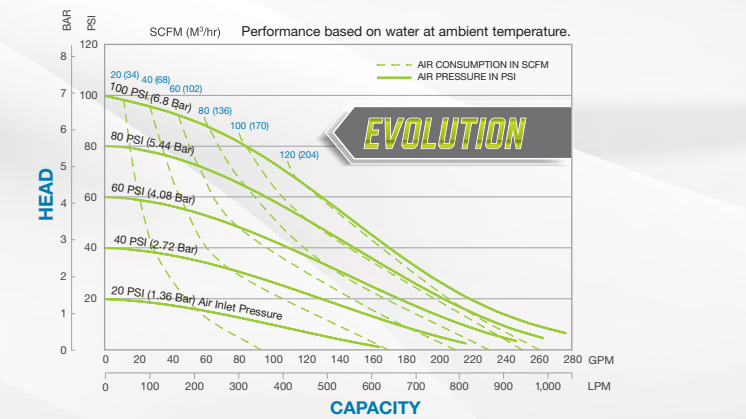

Genuine Parts Service Videos

We make it easy for you to repair your pump with detailed service videos that teach you how to maintain your SANDPIPER pump right, from the advice of our experienced and certified support team.

LEARN MORE AT SANDPIPERPUMP.COM/VIDEOS



*Conductive versions of this material are available.

STANDARD DUTY BALL VALVE PUMPS

OFFERING THE WIDEST RANGE OF PERFORMANCE AND APPLICATION CAPABILITIES

Standard Duty Metallic Pumps are ideally suited for intermittent / on-demand, portable, moderately abrasive fluids, and suspended solids. Standard duty pumps are constructed in Aluminum, Cast Iron, Stainless Steel and non-metallic materials such as PTFE, Polypropylene, and PVDF with elastomer TPE (thermal plastic elastomers) and PTFE options in diaphragms and check valves.

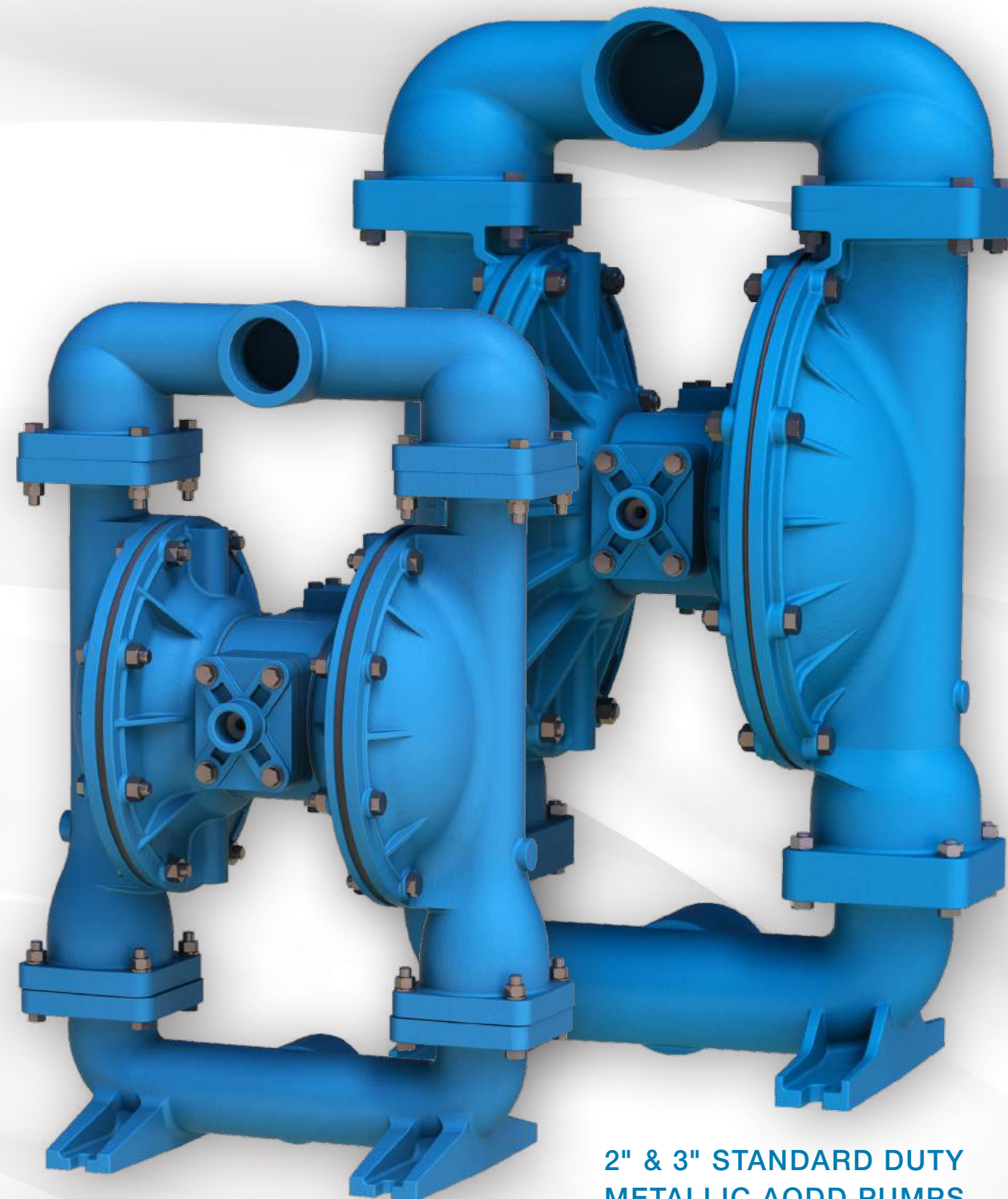

2" & 3" STANDARD DUTY METALLIC AODD PUMPS



Lightweight & Portable

Weights as low as 4 lbs (1.8 kg)



All Bolted Construction

Durable and high pressure capable



Top Discharge

For pumping out of tough areas



Ball Check Valves

Provide powerful, high flow pumping



Diaphragm Connecting Rods

Reliable and consistent diaphragm control



ESADS+Plus Air Valve

Externally Serviceable Air Distribution System



Dynamic Manifold Connections

90° - 180° rotation options



Certifications Available



| CHARACTERISTICS | | Metallic | Non-Metallic | |
|-----------------------|----------------------------------|----------|--------------|---|
| Fluid Characteristics | Water | + | + | |
| | Suspended Solids | + | ✓ | |
| | Non-Suspended Solids | ! | X | |
| | Line Size Solids | X | X | |
| | Sludge / Slurry | ✓ | ! | |
| | High Viscosity (Flowable Fluids) | ✓ | ✓ | |
| | Erosion / Abrasive Fluids | High | ✓ | ! |
| | | Moderate | ✓ | ! |
| Low | | + | ✓ | |
| Corrosion | ✓ | + | | |
| Installation | Permanent | ✓ | ✓ | |
| | Portable | + | + | |
| | Containment / Prevention | ! | ! | |
| | Flooded Suction | ✓ | ✓ | |
| | Suction Lift | ✓ | ✓ | |
| | Submerged | ✓ | ! | |
| Duty | Intermittent / On-Demand | + | + | |
| | Continuous | ✓ | ✓ | |

+ = Best Type ✓ = Suitable ! = Limitations X = Not Recommended

What is

EVOLUTION ?

OPTIMIZED PERFORMANCE |

Optimized performance without sacrificing **proven reliability**. These pumps have undergone an engineering **EVOLUTION**, leveraging trusted and proven product designs to **improve their performance** by application of advanced engineering methods. Unlike the competition, these pumps are **fully interchangeable** with prior models.

Check out the **S20 & S30 Metallic updates** on page 39. Watch for **more Engineering Evolutions** to come in the near future!

STANDARD DUTY BALL VALVE PUMPS

PERFORMANCE & SPECIFICATIONS

1/4"
6mm

X02 Metallic Performance



- MAX FLOW** • 4.75 GPM (18 LPM)
PORTING • BSP Parallel
AIR END • Stainless Steel
WET END • Stainless Steel

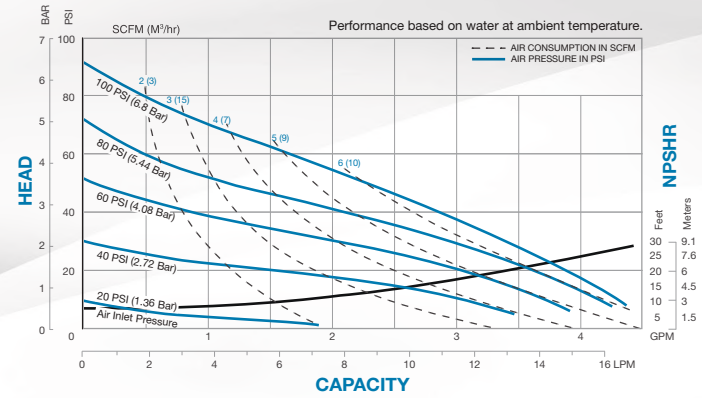

1/2"
12mm

S05 Metallic Performance



- MAX FLOW** • 15 GPM (57 LPM)
PORTING • NPT / BSP
• ANSI Flange
AIR END • Aluminum
WET END • Aluminum
• Stainless Steel

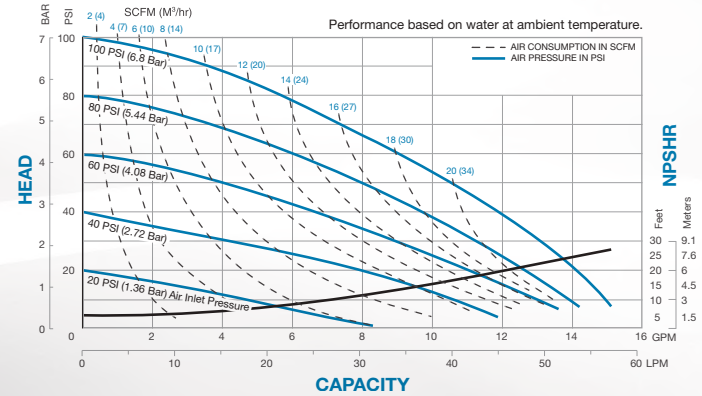

1"
25mm

S1F Metallic Performance



- MAX FLOW** • 45 GPM (170 LPM)
PORTING • NPT / BSP
• ANSI Flange
AIR END • Aluminum
WET END • Cast Iron
• Aluminum
• Stainless Steel

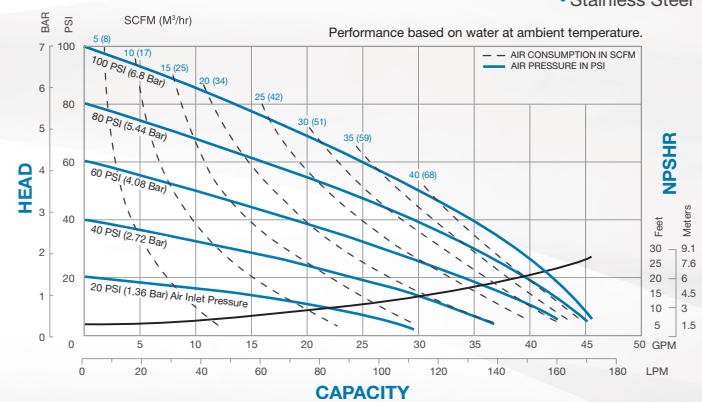

1 1/2"
38mm

S15 Metallic Performance



- MAX FLOW** • 106 GPM (401 LPM)
PORTING • NPT / BSP
• ANSI Flange
AIR END • Aluminum
WET END • Cast Iron
• Aluminum
• Stainless Steel

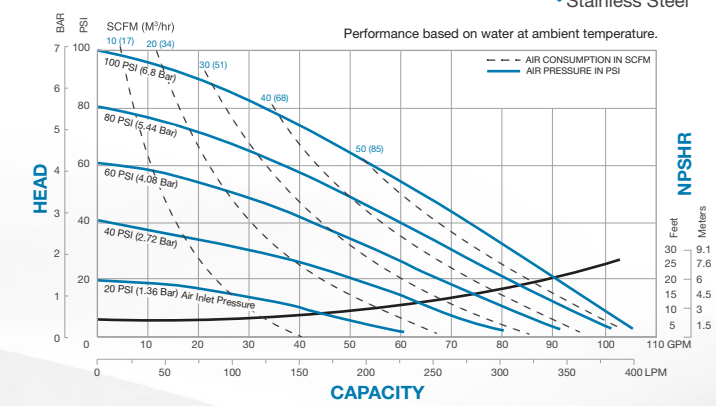

2"
50mm

S20 Metallic Performance



- MAX FLOW** • 200 GPM (758 LPM)
PORTING • NPT / BSP
• ANSI / DIN Flange
AIR END • Aluminum
WET END • Aluminum
• Stainless Steel
• Cast Iron

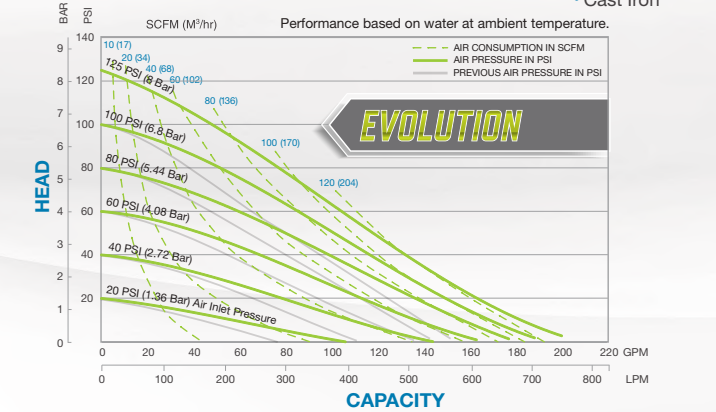

3"
75mm

S30 Metallic Performance



- MAX FLOW** • 285 GPM (1,078 LPM)
PORTING • NPT / BSP
• ANSI / DIN Flange
AIR END • Aluminum
WET END • Aluminum
• Stainless Steel
• Cast Iron

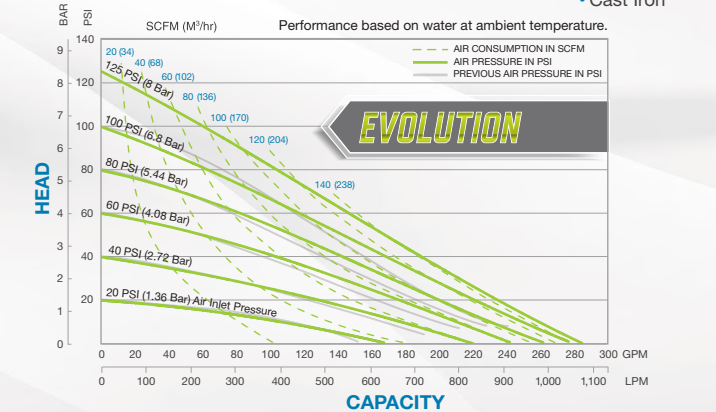

Genuine Parts Service Kits

- Everything in One Place.
- Reduce Frequency of Repairs.
- Increase Uptime.
- Save Time and Money.

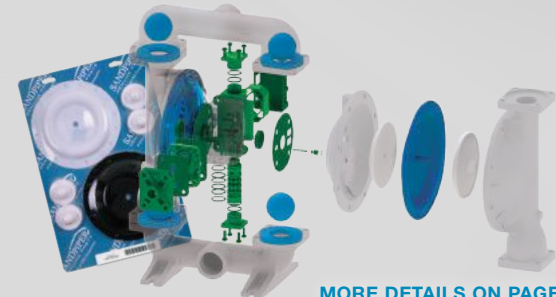

MORE DETAILS ON PAGE 66

STANDARD DUTY BALL VALVE PUMPS

PERFORMANCE & SPECIFICATIONS

1/4"
6mm

PB 1/4 Non-Metallic Performance



- MAX FLOW**
• 4 GPM (15 LPM)
- PORTING**
• NPT
- AIR END**
• Polypropylene
• Conductive Acetal
- WET END**
• Polypropylene
• PVDF
• Conductive Acetal

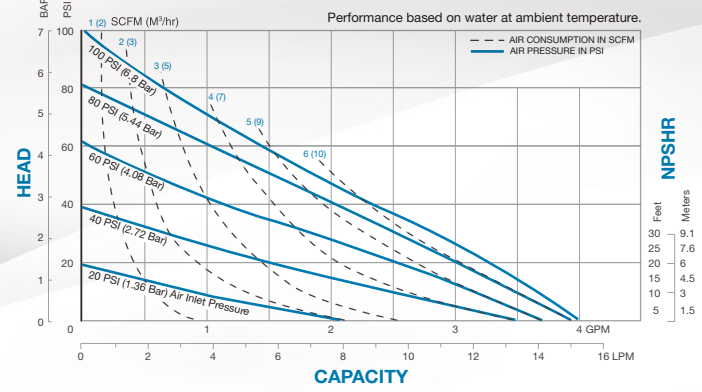

3/8"
9mm

WR10 Non-Metallic Performance



- MAX FLOW**
• 6.8 GPM (26 LPM)
- PORTING**
• NPT / BSP
- AIR END**
• PTFE
- WET END**
• PTFE
• PVDF

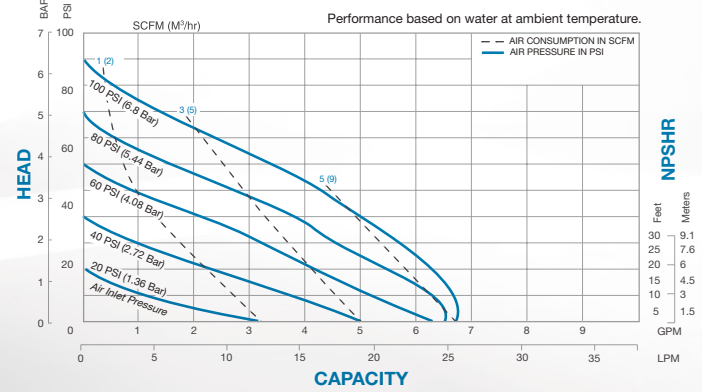

1/2"
12mm

S05 Non-Metallic Performance



- MAX FLOW**
• 14 GPM (52 LPM)
- PORTING**
• NPT / BSP
- AIR END**
• Polypropylene
• Conductive Polypropylene
- WET END**
• Polypropylene / Conductive Polypropylene
• Nylon
• PVDF / Conductive PVDF
• Conductive Acetal

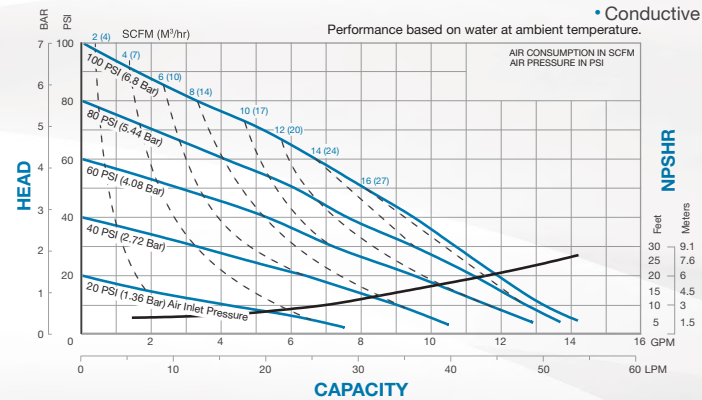

3/4"
19mm

S07 Non-Metallic Performance



- MAX FLOW**
• 23 GPM (87 LPM)
- PORTING**
• NPT / BSP
- AIR END**
• Polypropylene
- WET END**
• Polypropylene
• Nylon
• PVDF

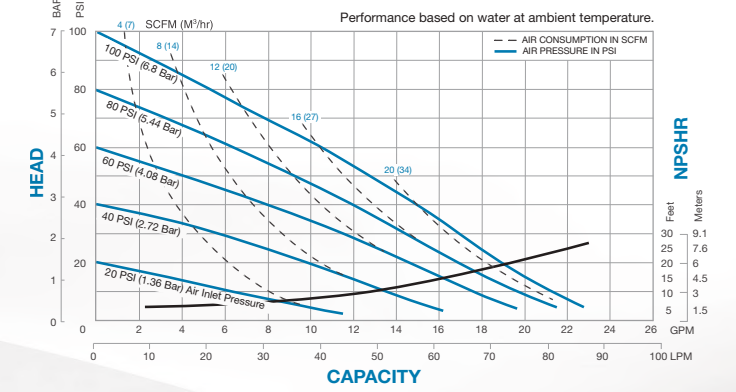

1"
25mm

S10 Non-Metallic Performance



- MAX FLOW**
• 23 GPM (87 LPM)
- PORTING**
• ANSI Flange
- AIR END**
• Polypropylene
- WET END**
• Polypropylene
• Nylon
• PVDF

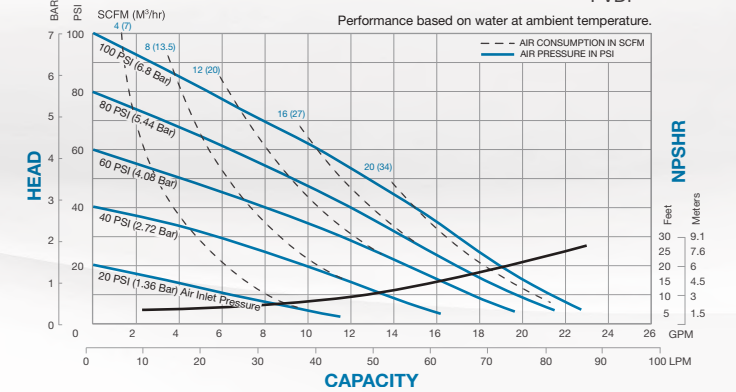

1"
25mm

S1F Non-Metallic Performance



- MAX FLOW**
• 53 GPM (200 LPM)
- PORTING**
• ANSI Flange
• DIN Flange
• NPT
- AIR END**
• Polypropylene
• 40% Glass Filled Polypropylene
• Conductive Polypropylene
- WET END**
• Polypropylene
• PVDF
• Conductive Polypropylene
• Conductive PVDF

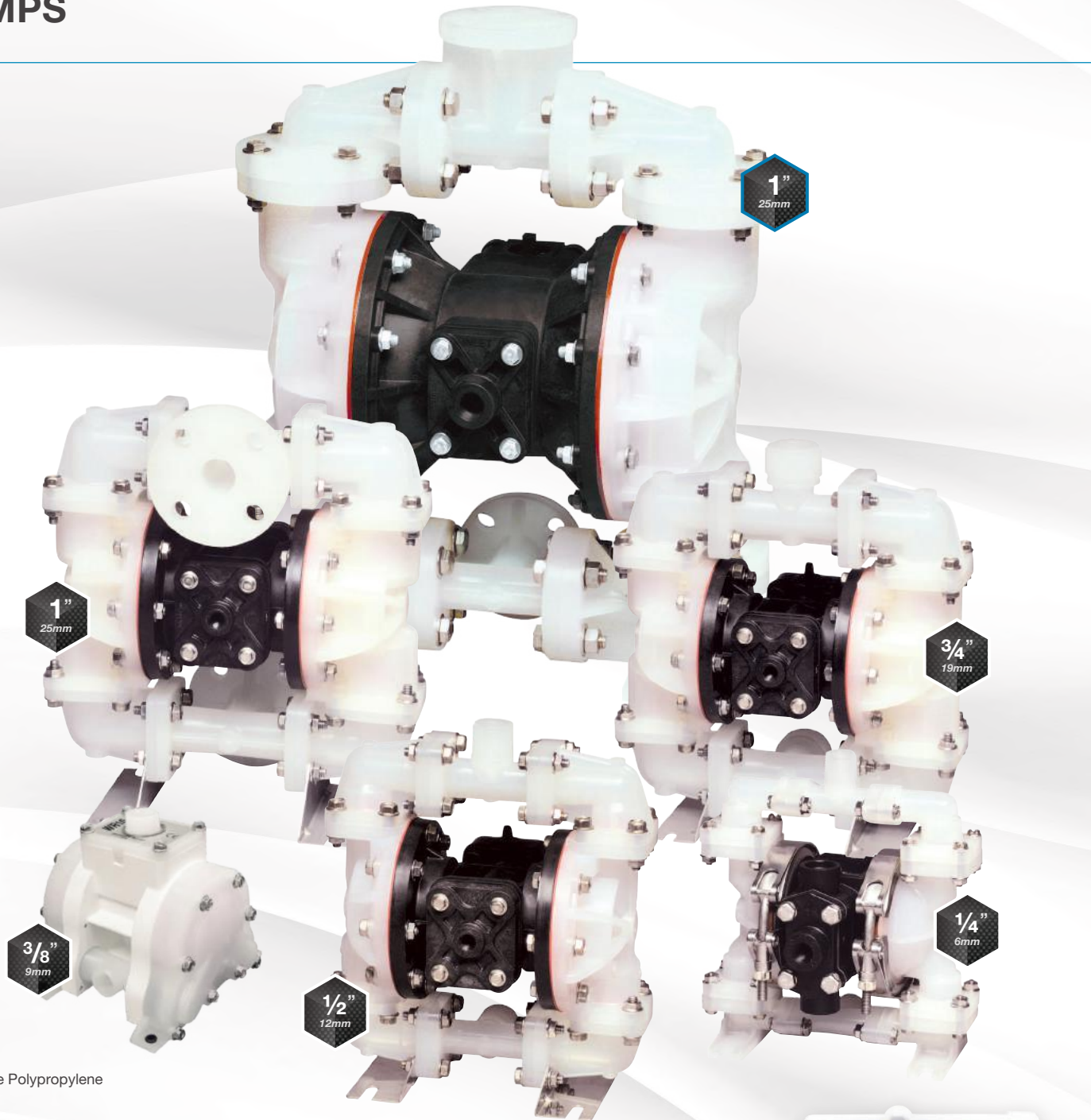
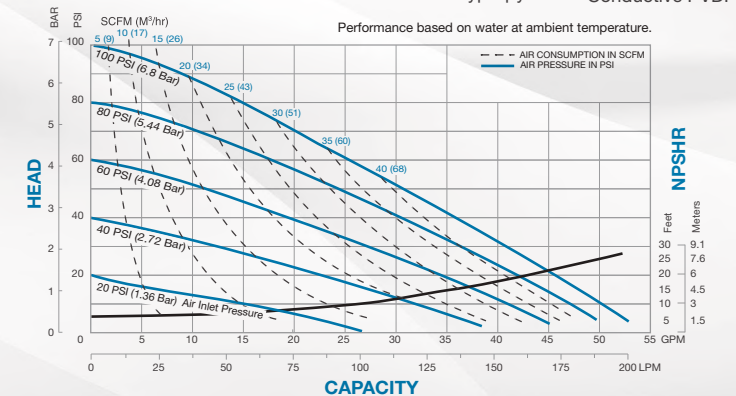

SANDPIPER Mobile App

The SANDPIPER Mobile App can save you time and money by allowing you to track your pump maintenance, submit quotes for kit purchasing and have instant access to many other tools and resources.

ACCESS EXCLUSIVELY AT SANDPIPER.AODDPUMPONLINE.COM



In-line ported options also available on S05 and S1F

STANDARD DUTY BALL VALVE PUMPS

PERFORMANCE & SPECIFICATIONS

1 1/2"
38mm

S15 Non-Metallic Performance



- MAX FLOW**
• 100 GPM (378 LPM)
- PORTING**
• ANSI Flange
• DIN Flange
- AIR END**
• Polypropylene
• Conductive Polypropylene
- WET END**
• Polypropylene
• PVDF
• Conductive Polypropylene

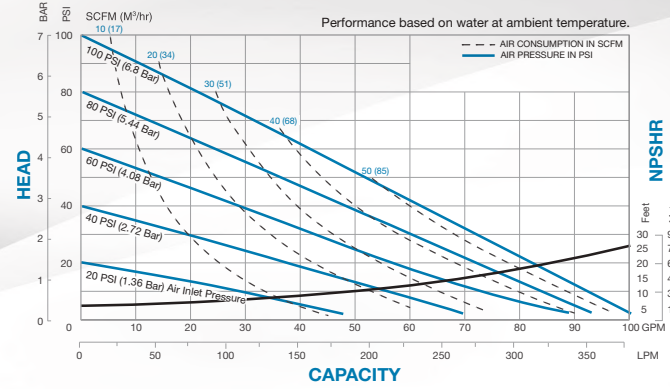

2"
50mm

S20 Non-Metallic Performance



- MAX FLOW**
• 160 GPM (605 LPM)
- PORTING**
• Universal Flange
- AIR END**
• Polypropylene
• Conductive Polypropylene
- WET END**
• Polypropylene
• PVDF
• Conductive Polypropylene

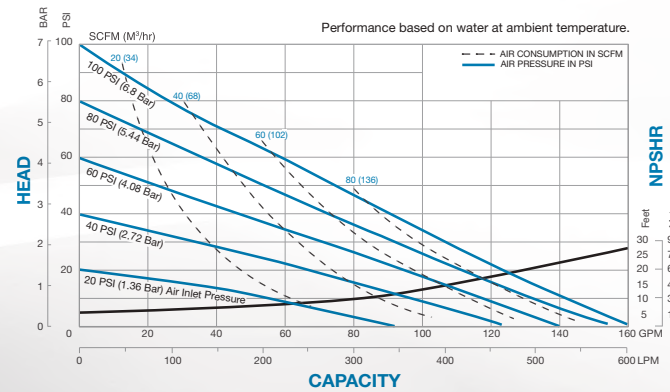

3"
75mm

S30 Non-Metallic Performance



- MAX FLOW**
• 280 GPM (1,061 LPM)
- PORTING**
• ANSI Flange
• DIN Flange
- AIR END**
• Glass Filled Polypropylene
- WET END**
• Polypropylene
• PVDF

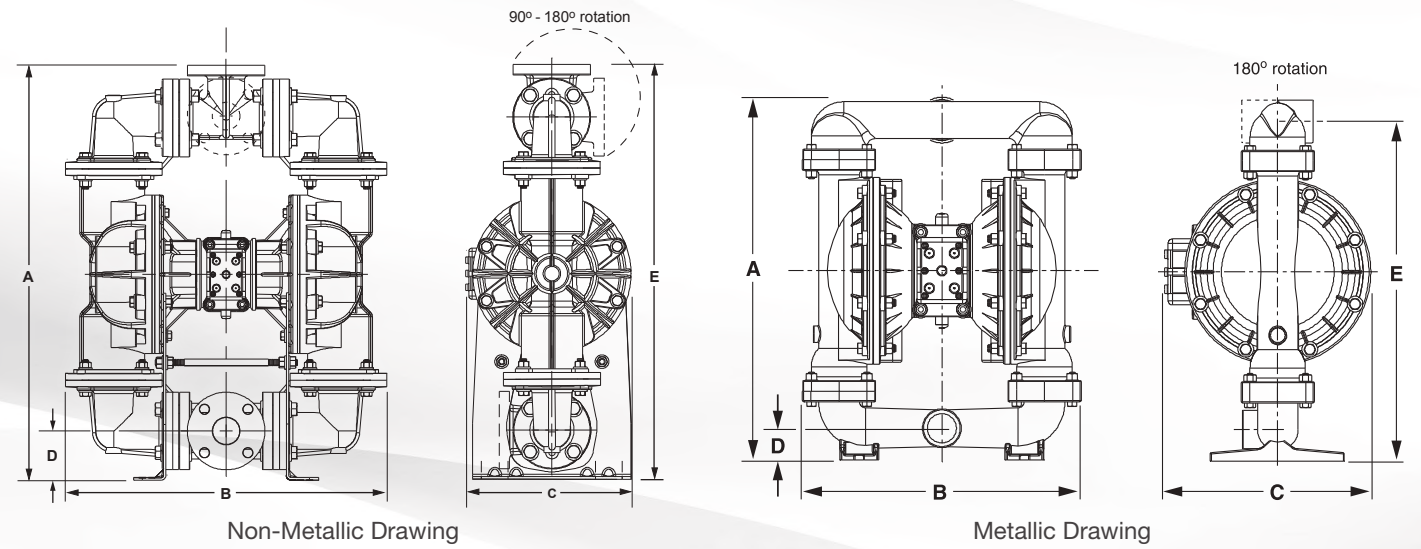
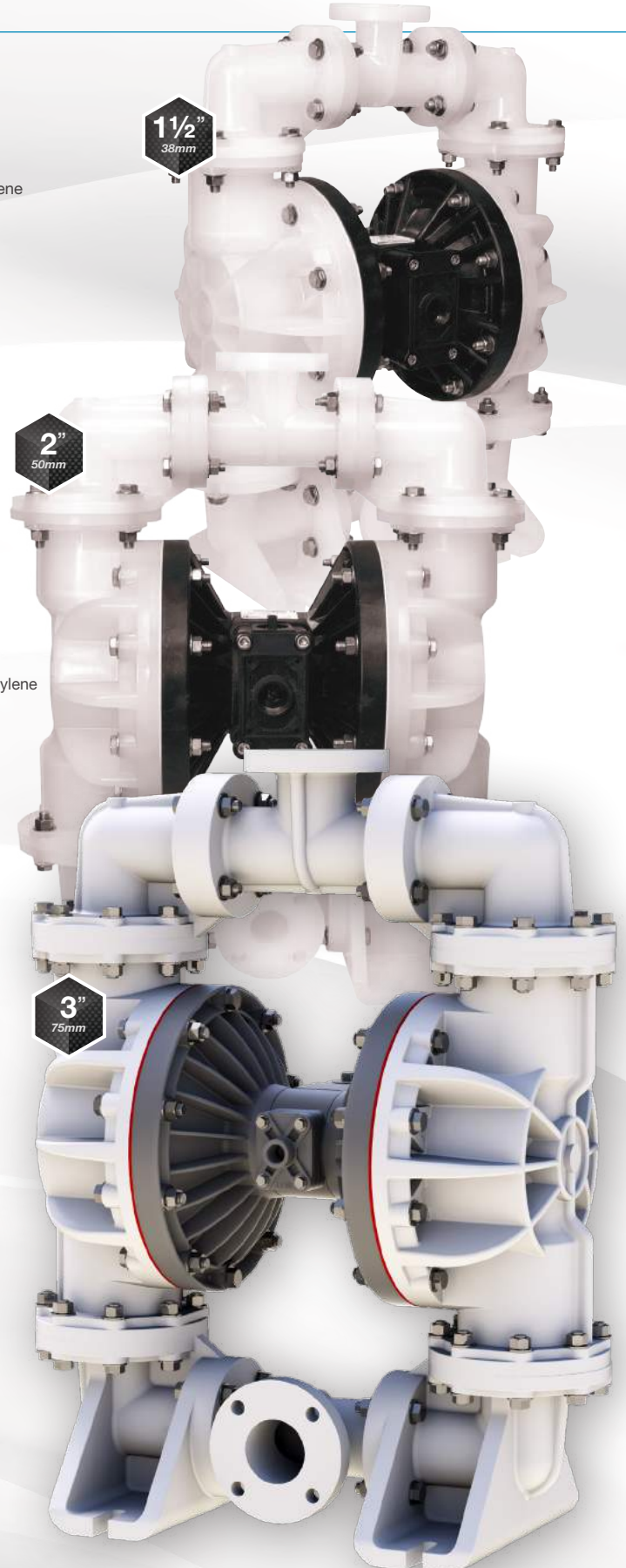
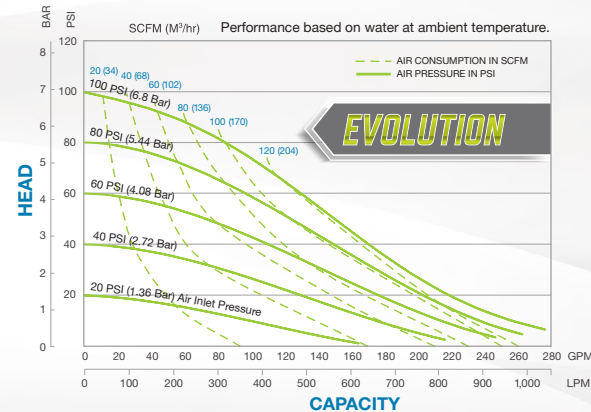

| METALLIC SPECIFICATIONS | | | | | | | | | | | |
|-------------------------|-------------|-------------|-------------|-------------------------------------------------------|-------------|------------------|-----------|-------------------------|---------------------|---------------------|------------------------|
| PUMP MODELS | A | B | C | D | | Connection Style | Pipe Size | Displacement Per Stroke | Max Flow Per Minute | Max Solids Handling | Max Discharge Pressure |
| | Height | Width | Depth | Bottom of Base to Center Line of: Suction / Discharge | | | | | | | |
| | inches (mm) | inches (mm) | inches (mm) | inches (mm) | inches (mm) | | inch (mm) | gal (liter) | gal (liter) | inch (mm) | psi (bar) |
| X02 | 5.81 (148) | 7.44 (189) | 4.38 (111) | .63(16) | 5.41 (138) | 1/4" NPT/BSP | .25 (6) | .003 (.01) | 4.75 (18) | .08 (2) | 125 (8.6) |
| S05 AL | 11.5 (292) | 10.25 (260) | 7.44 (179) | 1.94 (33) | 11.5 (292) | 1/2" NPT/BSP | .5 (12) | .026 (.098) | 15 (57) | .13 (3) | 125 (8.6) |
| S05 SS | 10.38 (264) | 10.25 (260) | 7.44 (179) | 1.31 (33) | 9.72 (247) | 1/2" NPT/BSP | .5 (12) | .026 (.098) | 15 (57) | .13 (3) | 125 (8.6) |
| S1F AL / CI | 12.72 (323) | 10.25 (260) | 10.38 (264) | 1.09 (28) | 11.84 (301) | 1" NPT/BSP | 1 (25) | .11 (42) | 45 (170) | .25 (6) | 125 (8.6) |
| S1F SS | 12.84 (326) | 10.25 (260) | 10.38 (264) | 1.22 (31) | 11.97 (304) | 1" NPT/BSP | 1 (25) | .11 (42) | 45 (170) | .25 (6) | 125 (8.6) |
| S15 AL / CI | 21.58 (548) | 16.66 (423) | 12.36 (314) | 1.91 (49) | 20.31 (516) | 1 1/2" NPT/BSP | 1.5 (38) | .41 (1.55) | 106 (401) | .25 (6) | 125 (8.6) |
| S15 SS | 21.66 (550) | 16.66 (423) | 12.36 (314) | 1.97 (50) | 20.38 (518) | 1 1/2" NPT/BSP | 1.5 (38) | .41 (1.55) | 106 (401) | .25 (6) | 125 (8.6) |
| S20 AL / CI | 26.31 (669) | 16.88 (428) | 12.59 (320) | 1.88 (48) | 24.63 (625) | 2" NPT/BSP | 2 (50) | .42 (1.59) | 200 (758) | .25 (6) | 125 (8.6) |
| S20 SS | 26.31 (669) | 16.88 (428) | 12.59 (320) | 2 (50) | 24.75 (629) | 2" NPT/BSP | 2 (50) | .42 (1.59) | 200 (758) | .25 (6) | 125 (8.6) |
| S30 AL/CI | 32.06 (814) | 19.66 (499) | 15.75 (400) | 2.34 (60) | 29.97 (761) | 3" NPT/BSP | 3 (75) | .94 (3.56) | 285 (1,078) | .38 (9.5) | 125 (8.6) |
| S30 SS | 32.28 (820) | 19.66 (499) | 15.75 (400) | 2.28 (65) | 30.19 (767) | 3" NPT/BSP | 3 (75) | .94 (3.56) | 285 (1,078) | .38 (9.5) | 125 (8.6) |

Dimensional Tolerance: ±1/8" (±3mm) • See service manual for complete specifications.

| NON-METALLIC SPECIFICATIONS | | | | | | | | | | | |
|-----------------------------|--------------|-------------|-------------|-------------------------------------------------------|--------------|--------------------|-----------|-------------------------|---------------------|---------------------|------------------------|
| PUMP MODELS | A | B | C | D | | Connection Style | Pipe Size | Displacement Per Stroke | Max Flow Per Minute | Max Solids Handling | Max Discharge Pressure |
| | Height | Width | Depth | Bottom of Base to Center Line of: Suction / Discharge | | | | | | | |
| | inches (mm) | inches (mm) | inches (mm) | inches (mm) | inches (mm) | | inch (mm) | gal (liter) | gal (liter) | inch (mm) | psi (bar) |
| PB1/4 | 7.81 (198) | 7 (178) | 5.5 (140) | .75 (19) | 7.81 (198) | 1/4" NPT | .25 (6) | .01 (.04) | 4 (15) | .03 (1) | 100 (6.9) |
| WR10 | 5.32 (135) | 4.09 (104) | 5.72 (145) | 0.94 (24) | 0.94 (24) | 3/8" NPT | .375 (10) | .009 (.034) | 6.8 (26) | 0.1 (2.25) | 100 (6.9) |
| S05 | 11.31 (287) | 10.13 (257) | 7.06 (179) | 1.38 (35) | 11.31 (287) | 1/2" NPT | .5 (13) | .026 (.098) | 14 (52) | .125 (3) | 100 (6.9) |
| S07* | 13.34 (339) | 11.81 (300) | 7.06 (179) | 1.81 (46) | 13.34 (339) | 3/4" NPT | .75 (19) | .026 (.098) | 13 (48) | .38 (9) | 100 (6.9) |
| S07 | 13.34 (339) | 11.81 (300) | 7.06 (179) | 1.81 (46) | 13.34 (339) | 3/4" NPT | .75 (19) | .026 (.098) | 23 (87) | .15 (4) | 100 (6.9) |
| S10 | 13.81 (351) | 11.81 (300) | 7.56 (192) | 2.5 (64) | 11.69 (297) | 1" ANSI | 1 (25) | .026 (.098) | 23 (87) | .15 (4) | 100 (6.9) |
| S1F | 21 (533) | 17 (433) | 11.63 (295) | 2.5 (64) | 21 (533) | 1" U | 1 (25) | .19 (.72) | 53 (200) | .25 (6) | 100 (6.9) |
| S15 | 28.75 (730) | 23 (584) | 13 (330) | 3.5 (89) | 25.19 (640) | 1 1/2" ANSI or DIN | 1.5 (38) | .36 (1.36) | 100 (378) | .47 (12) | 100 (6.9) |
| S20 | 32.25 (819) | 23.81 (605) | 13 (330) | 3.81 (97) | 28.19 (716) | 2" U | 2 (50) | .36 (1.36) | 160 (605) | .66 (17) | 100 (6.9) |
| S30 | 40.66 (1033) | 32.31 (821) | 16.19 (411) | 4.85 (123) | 40.66 (1033) | 3" ANSI or DIN | 3 (75) | 1.0 (3.78) | 280 (1061) | .75 (19) | 100 (6.9) |

Dimensional Tolerance: ±1/8" (±3mm) • See service manual for complete specifications.

U = Universal: Fits both ANSI or DIN.
*T = Trihedral.

SPECIAL DUTY

THE SAME QUALITY SANDPIPER PRODUCTS DESIGNED TO FIT SPECIFIC NEEDS

PAGE
48

NATURAL GAS PUMPS

CSA certified to ANSI LC6 standard and Canadian Technical Letter No. R-14 for operation using sweet or sour natural gas

PAGE
50

UL LISTED PUMPS

Designed to meet UL79 standards for diaphragm pumps handling flammable liquids

PAGE
51

SUBMERSIBLE CENTRIFUGAL PUMPS

Lightweight and powerful pumps great for high flow and close quarters pumping situations

PAGE
52

PREMIUM FDA COMPLIANT PUMPS

Regulation 1935/2004/EC Compliant and the ultimate in leak protection and clean pumping with the paired performance of AODD technology

PAGE
54

FDA COMPLIANT PUMPS

Regulation 1935/2004/EC Compliant and ideally suited for a variety of food processing, pharmaceutical and cosmetic industry applications

PAGE
56

HIGH PRESSURE PUMPS

Deliver discharge pressure twice the inlet pressure, up to 250 PSI (17 BAR)



Submersible - PortaPump



Natural Gas - G20



VS COMPETITOR

SANDPIPER PUMPS EXCEL IN EVERY ASPECT OF SAFETY AND RELIABILITY WITHIN THE OIL & GAS INDUSTRY

WIDEST AVAILABLE RANGE

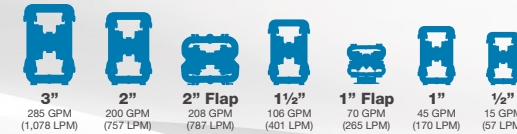

WIDEST TEMPERATURE RANGE

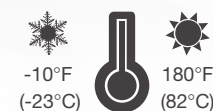

BROADEST CERTIFICATIONS IN THE INDUSTRY

SAFETY COMPLIANCE WITH:



LARGEST SOLIDS PASSAGE



EASE OF REPAIR & LESS DOWNTIME

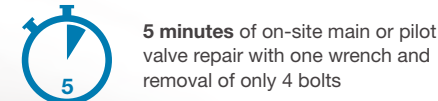

ENHANCED TEMPERATURE RESISTANCE AND CHEMICAL COMPATIBILITY

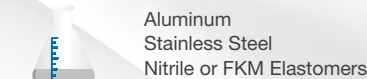

BEST GUARANTEE IN THE INDUSTRY

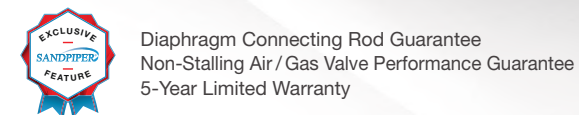

SIZE & FLOW



TEMP



SAFETY

SAFETY COMPLIANCE WITH:



SOLIDS HANDLING

TOP DISCHARGE ONLY
Up to 1/4 inch



GAS / AIR VALVE REPAIR

55 minutes of off-site main and pilot valve repair with a variety of tools needed to remove pump from line and transport for repair



GAS / AIR END MATERIALS

LIMITED
Aluminum only
Nitrile Elastomers only



PERFORMANCE RELIABILITY

LIMITED
Connecting Rod prone to bending
5-year Limited Warranty



OIL & GAS PROCESS MAP

LAND, OFFSHORE & DRILLING RIG APPLICATIONS

ONSHORE APPLICATIONS

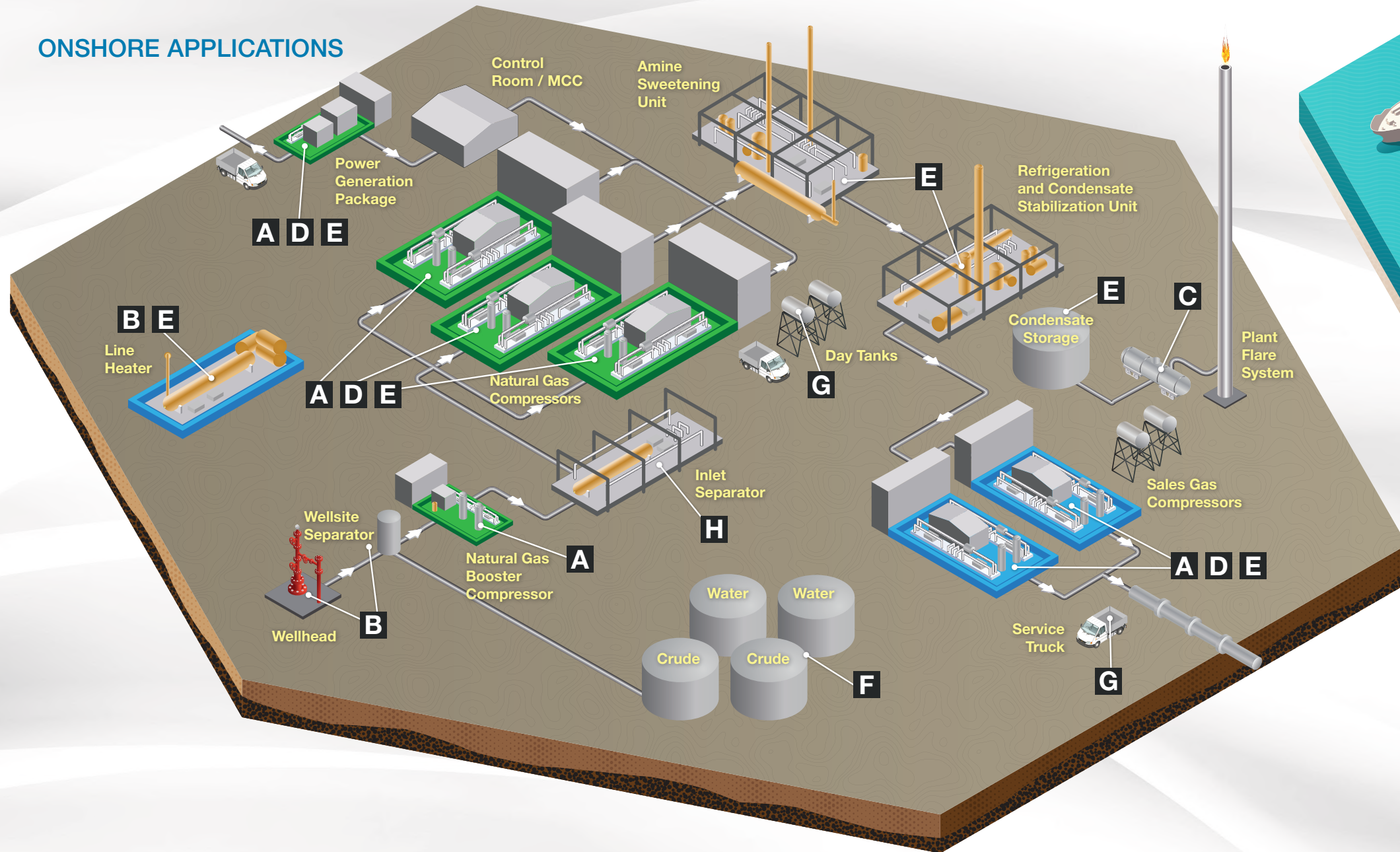

OFFSHORE APPLICATIONS

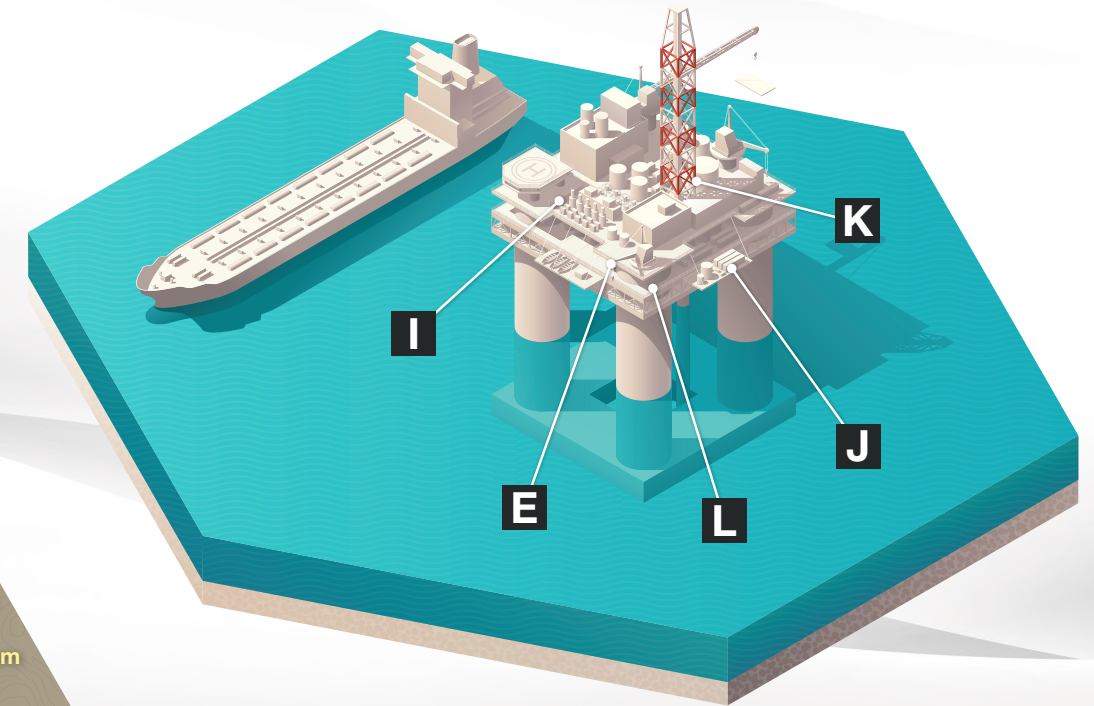

DRILLING RIG APPLICATIONS

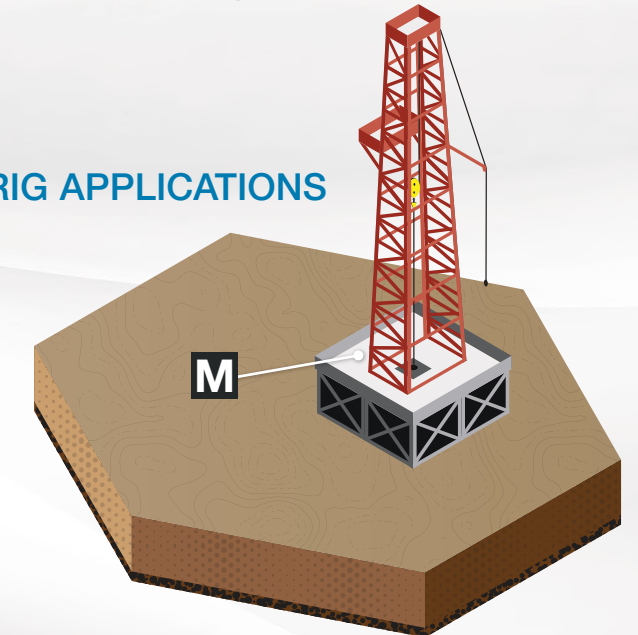

APPLICATIONS KEY:

- | | | | |
|-------------------------------------------------------|-----------------------------------------------------------------------------|--------------------------------------------------------|------------------------------------------------------------------|
| A Lube Oil Transfer (G05, G1F) | E Sump / General Transfer (G05, G1F, G15, G10F, G20F) | H Separators & Knockout Drums (G20, GH2-M) | L Produced Water / Condensate Transfer (G1F) |
| B Glycol Recirculation / Heat Trace (G05, G1F) | F Tank Bottom Recirculation / Transfer (G10F, G20F, G20, G30, GH2-M) | I General Duty Spill Clean-Up (G20F, G20, G30) | M Cellar Pump-Out & Mud Transfer (G20F, HDF2, HDF3, SMA3) |
| C Flare Knockout (G1F, G15, G20, ST1, ST1½) | G Utility / General Transfer (G05, G1F, G15, G10F, G20F) | J Diesel Fuel Transfer (G15) | |
| D Glycol Transfer / Water Make-Up (G05, G1F) | | K Sea Water Pump for Drilling Mud Make-Up (G30) | |

DUAL POWER NATURAL GAS OR AIR OPERATED PUMPS

CSA CERTIFIED

FLAP VALVE PUMPS

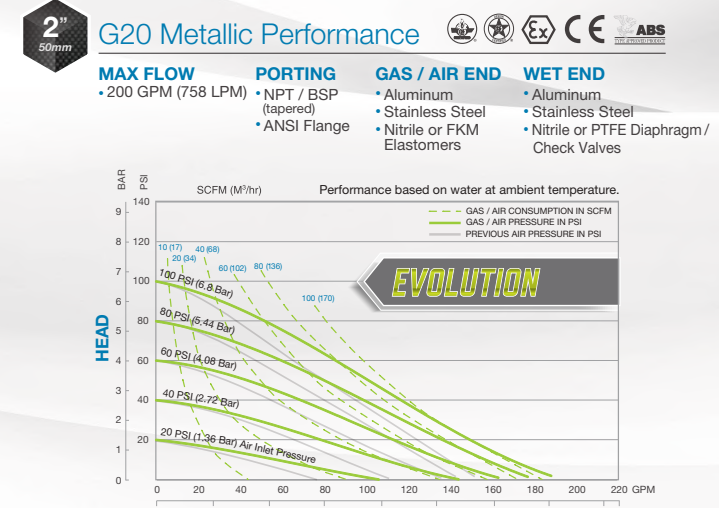
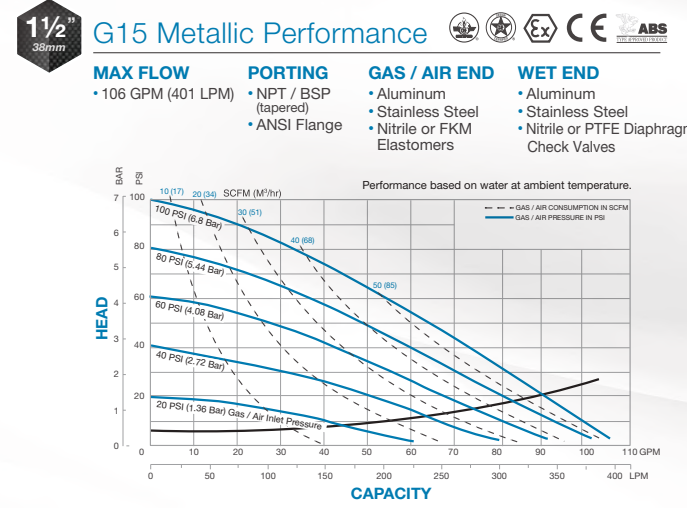
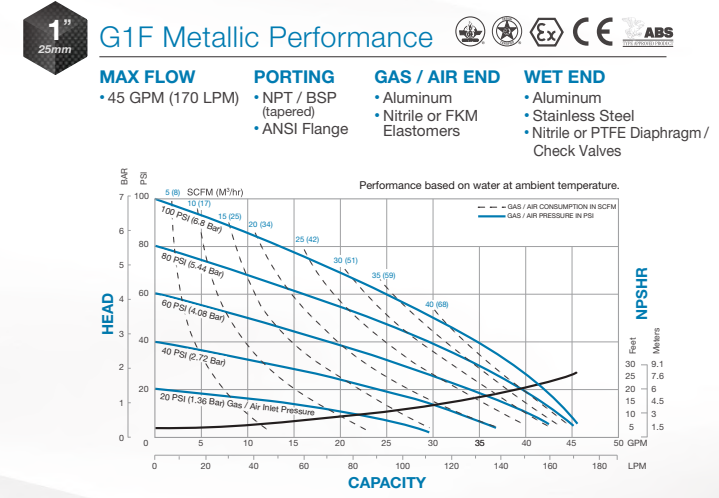
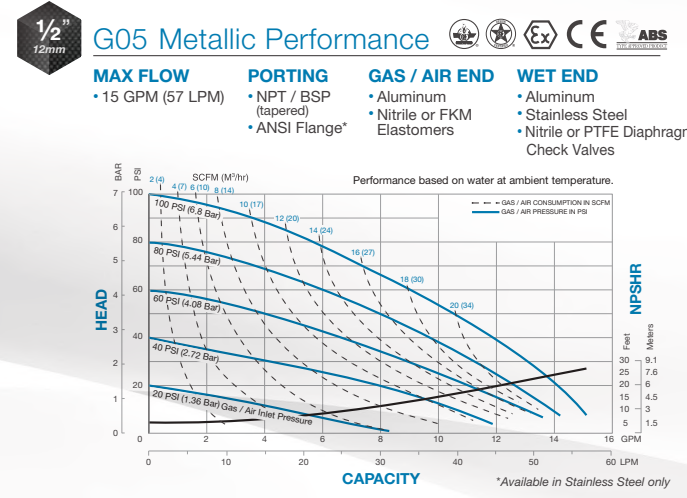
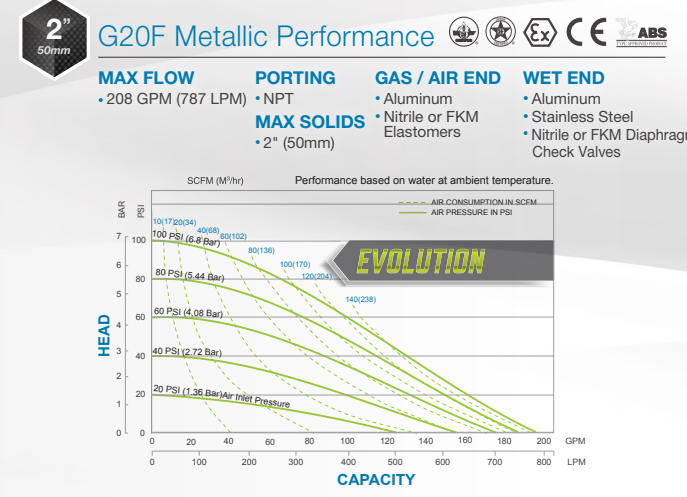
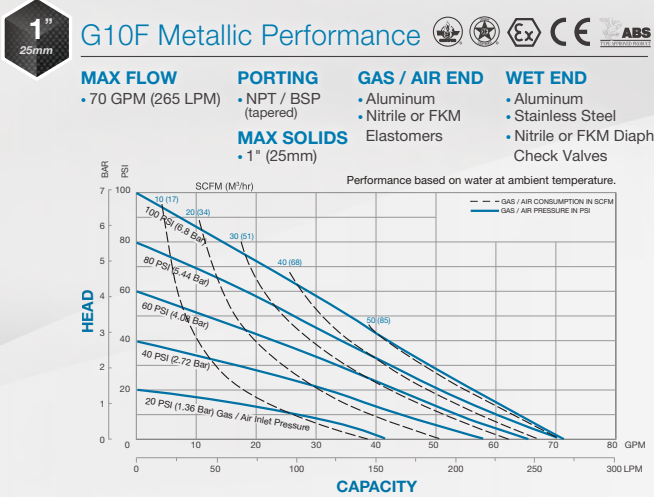

- Remote Site Serviceability**
ESADS+Plus Air / Gas System allows for an on-site maintenance time of only 5 minutes
- Temperature Limits**
-10°F (-23°C) to 180°F (82°C)

- Hydrostatic Strength Test**
500 PSI (34.5 BAR)
- Nitrile or FKM Elastomers**
Air / Gas End options for varying temperatures and chemical compatibility

SANDPIPER G-SERIES™



CSA is the Canadian Standards Association, an international organization for testing products to ensure public safety, and the governing agency for the Natural Gas Industry.

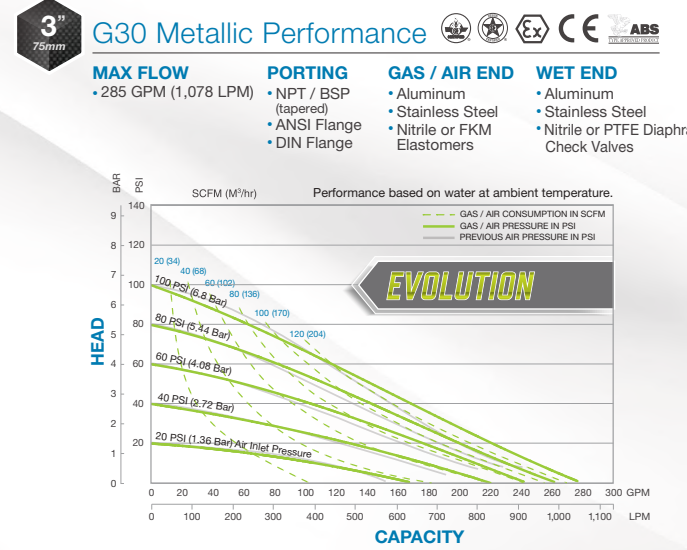

DUAL POWER

DESIGNED & TESTED TO BE SAFELY POWERED BY COMPRESSED AIR OR NATURAL GAS

All SANDPIPER G-Series™ pumps feature *Dual Power* capabilities and may be safely powered by compressed air or natural gas depending on the application, which offers simplified purchasing, maintenance and training while reducing inventory.

UL LISTED PUMPS

PERFORMANCE & SPECIFICATIONS

UL (Underwriters Laboratories) Listed Pumps are designed to meet UL79 standards for diaphragm pumps handling flammable liquids. All Aluminum construction with approved Nitrile or Virgin PTFE UL elastomers. Fully groundable to prevent static discharge.



1" 25mm U1F Metallic Performance

- MAX FLOW** • 45 GPM (170 LPM)
- PORTING** • NPT / BSP
- AIR END** • Aluminum
- WET END** • Aluminum

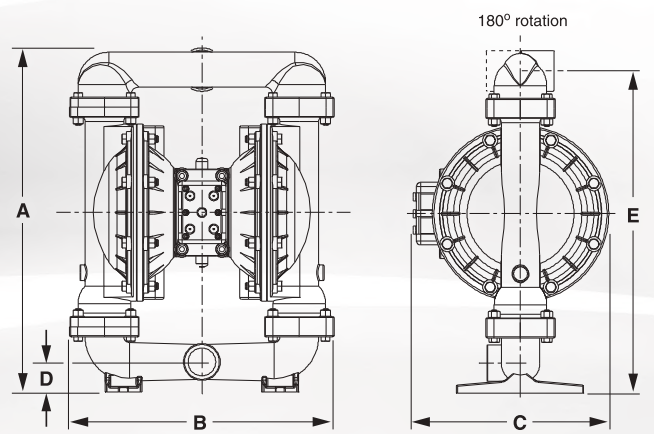
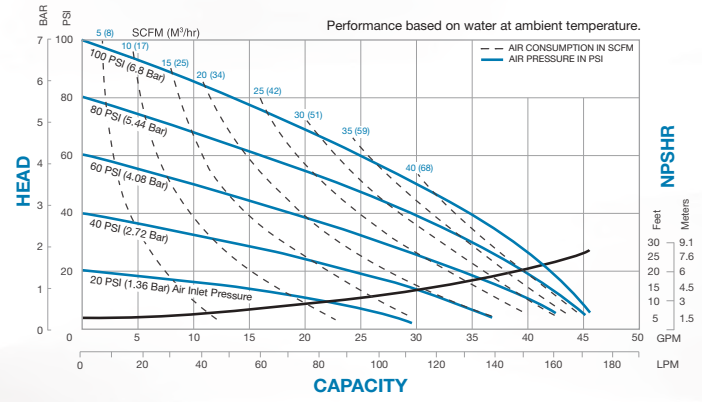

SCAN TO LEARN MORE
SANDPIPERPUMP.COM/ULPUMPS

| SPECIFICATIONS | | | | | | | | | | | |
|----------------|-------------|-------------|-------------|------------------------------------------|-----------------------|------------------|-----------|-------------------------|---------------------|---------------------|------------------------|
| PUMP MODELS | A | B | C | D | E | Connection Style | Pipe Size | Displacement Per Stroke | Max Flow Per Minute | Max Solids Handling | Max Discharge Pressure |
| | Height | Width | Depth | Bottom of Base to Center Line of Suction | Center Line Discharge | | inch (mm) | gal (liter) | gal (liter) | inch (mm) | psi (bar) |
| U1F | 12.72 (323) | 10.25 (260) | 10.38 (264) | 1.09 (28) | 11.84 (301) | 1" NPT | 1 (25) | .11 (.42) | 45 (170) | .25 (6) | 125 (8.6) |

Dimensional Tolerance: ±1/8" (± 3mm) • See service manual for complete specifications

SUBMERSIBLE CENTRIFUGAL PUMPS

PERFORMANCE & SPECIFICATIONS

The PortaPump® Submersible, Battery-Powered Pump operates using any 12-volt car or truck battery. It comes equipped with cables and battery clips. Extremely portable, the pump weighs only 33 pounds (15 kg) and can fit through openings as small as 10" (25cm). Electrically safe and whisper quiet.

1 1/2" 38mm SPA1 1/2-E Metallic Performance

- MAX FLOW** • 43 GPM (163 LPM)
- PORTING** • NPT / BSP
- WET END** • Aluminum

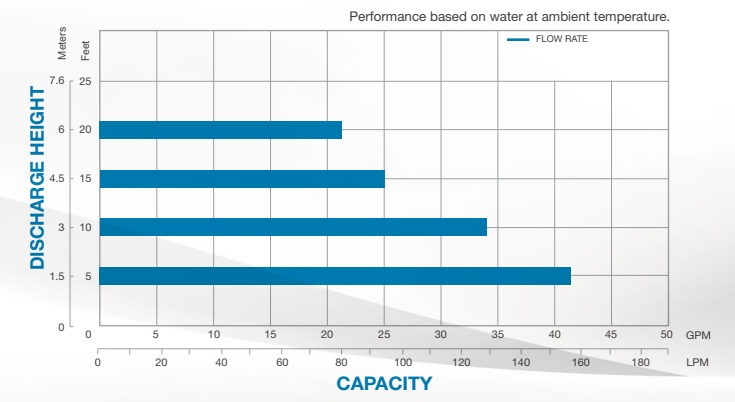

The SludgeMaster™ Submersible, Air-Powered Trash Pump handles mud, leaves, twigs, sand, sludge, trash-laden water and soft solids to 1 1/2" (3.8cm). High capacity, low head. The pump weighs only 59 pounds (26kg), and can fit through an opening as small as 14" (35cm). Sturdy construction for rough handling and long life. Optional rock screen available.

3" 75mm SMA3 Metallic Performance

- MAX FLOW** • 300 GPM (1140 LPM)
- PORTING** • NPT / BSP
- AIR END** • Aluminum
- WET END** • Aluminum

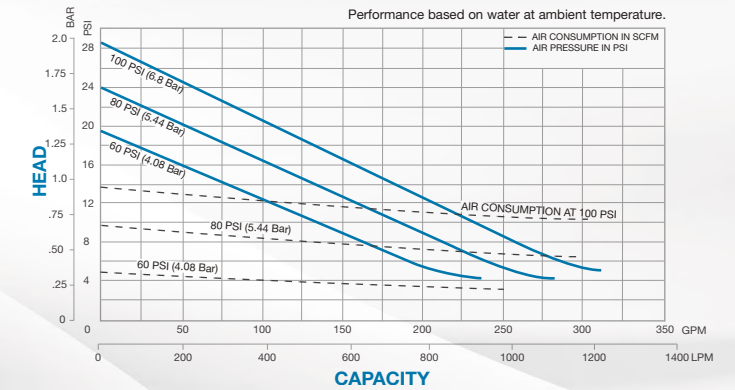

SCAN TO LEARN MORE
SANDPIPERPUMP.COM/SUBMERSIBLE

| SPECIFICATIONS | | | | | | | | | | | |
|----------------|-------------|------------|------------|--------------------------|---------|------------------|-----------|---------------------|---------------------|----------------------|--|
| PUMP MODELS | A | B | C | D | E | Connection Style | Pipe Size | Max Flow Per Minute | Max Solids Handling | Max Discharge Height | |
| | Height | Width | Depth | Base to Center Discharge | Weight | | inch (mm) | gal (liter) | inch (mm) | feet (m) | |
| SPA1 1/2-E | 22 (560) | 8.88 (225) | 6.19 (157) | 4.71 (119) | 33 (15) | 1 1/2" NPT | 1.5 (38) | 43 (163) | .06 (1) | 25 (7.6) | |
| SMA3 | 23.51 (597) | 13 (330) | 9 (229) | 7.11 (180) | 59 (26) | 3" NPT | 3 (75) | 300 (1140) | 1.5 (40) | 65 (19.8) | |

Dimensional Tolerance: ±1/8" (± 3mm) • See service manual for complete specifications

PREMIUM FDA COMPLIANT PUMPS

PERFORMANCE & SPECIFICATIONS

Our Premium FDA (Food & Drug Administration) Material Compliant Pumps are ideally suited for the ultimate in leak protection and clean pumping with the paired performance of AODD technology. Whether in a clean-in-place or clean-out-of-place application, these pumps will exceed the need for reliability and cleanability. Some of their most exceptional features include:

- Leak Detection**
Pair with Electronic Leak Detection [LEARN MORE ON PAGE 63](#)
- Materials Of Construction**
Electropolished 316 and 302/304 Stainless Steel Components
- Porting Options**
Rotatable manifolds

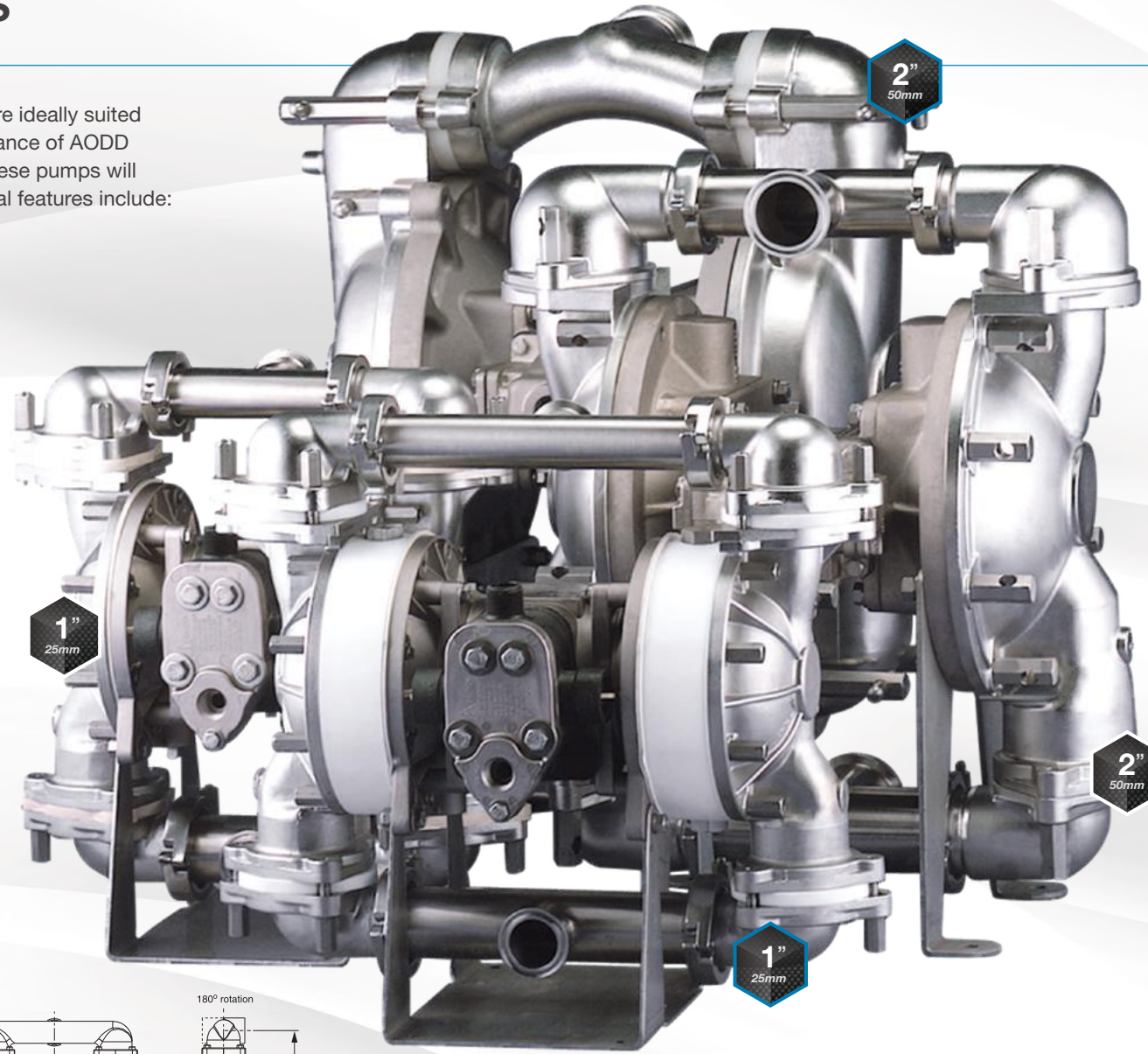

1" 25mm SSB1 / DSB1 Metallic Performance

- MAX FLOW** • 54 GPM (204 LPM)
- PORTING** • Tri-Clamp
- AIR END** • Nickel Plated Aluminum
- WET END** • Stainless Steel

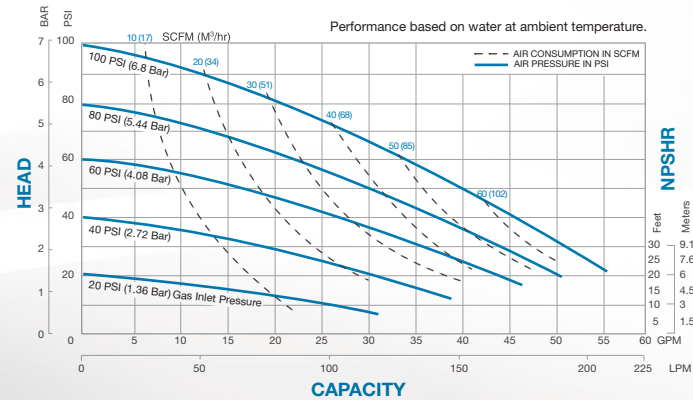

2" 50mm SSB2 Metallic Performance

- MAX FLOW** • 125 GPM (473 LPM)
- PORTING** • Tri-Clamp
- AIR END** • Nickel Plated Aluminum
- WET END** • Stainless Steel

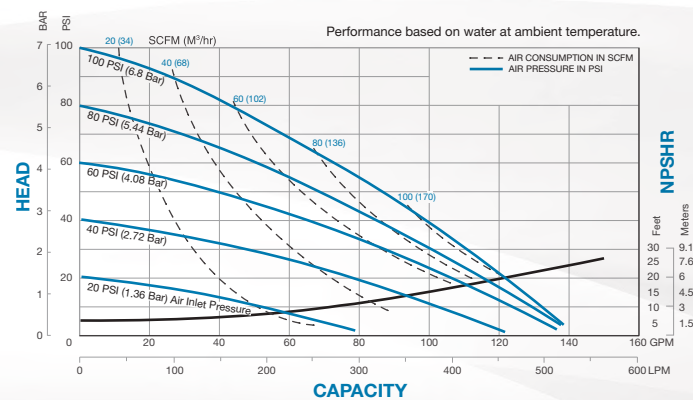

2" 50mm SSA2 Metallic Performance

- MAX FLOW** • 150 GPM (567 LPM)
- PORTING** • Tri-Clamp
- AIR END** • Nickel Plated Aluminum
- WET END** • Stainless Steel

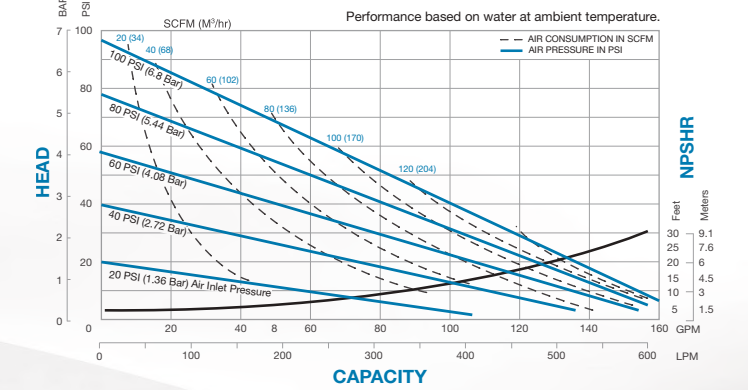

1" 25mm SET1 Metallic Performance

- MAX FLOW** • 54 GPM (204 LPM)
- PORTING** • Tri-Clamp
- AIR END** • Nickel Plated Aluminum
- WET END** • Stainless Steel

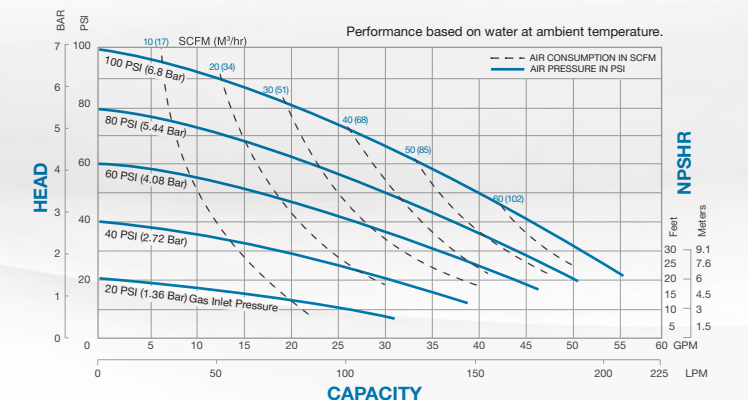

2" 50mm SET2 Metallic Performance

- MAX FLOW** • 123 GPM (465 LPM)
- PORTING** • Tri-Clamp
- AIR END** • Nickel Plated Aluminum
- WET END** • Stainless Steel

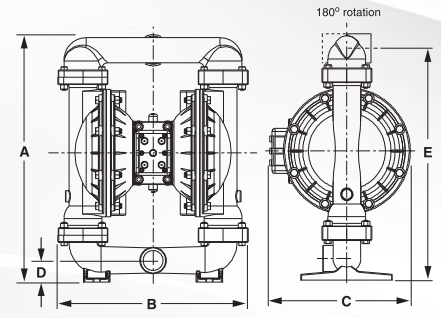
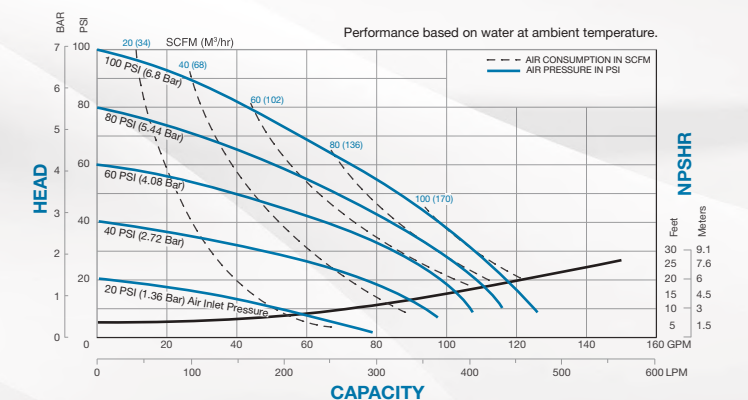

EC-1935
Food Processing plastic and elastomer food contact components meet the requirements of EU Regulation 1935/2004/EC. Refer to declaration of conformity for compliant models.

| PUMP MODELS | SPECIFICATIONS | | | | | Connection Style | Pipe Size | Displacement Per Stroke | Max Flow Per Minute | Max Solids Handling | Max Discharge Pressure |
|-------------|----------------|-------------|-------------|------------------------------------------|--------------------------|------------------|-----------|-------------------------|---------------------|---------------------|------------------------|
| | A | B | C | D | E | | | | | | |
| | Height | Width | Depth | Bottom of Base to Center Line of Suction | Center Line of Discharge | | | | | | |
| SSB1/DSB1 | 17.44 (443) | 15.69 (398) | 10.69 (271) | 2.38 (60) | 15.94 (404) | 1½" Tri-Clamp | 1 (25) | .09 (.34) | 54 (204) | .25 (6) | 125 (8.6) |
| SSB2 | 22.63 (575) | 18.88 (479) | 12.81 (325) | 2.75 (70) | 21 (533) | 2" Tri-Clamp | 2 (50) | .36 (1.36) | 125 (473) | .25 (6) | 125 (8.6) |
| SSA2 | 25.63 (651) | 20.06 (510) | 16.25 (413) | 3.94 (100) | 24.13 (612) | 2½" Tri-Clamp | 2 (50) | .63 (2.39) | 150 (570) | 1.06 (27) | 125 (8.6) |
| SET1 | 17.88 (454) | 19 (483) | 10.19 (268) | 2.38 (60) | 15.75 (400) | 1" Tri-Clamp | 1 (25) | .09 (.34) | 54 (204) | .25 (6) | 125 (8.6) |
| SET2 | 23.5 (597) | 24.13 (613) | 13 (330) | 2.38 (60) | 21.25 (540) | 2" Tri-Clamp | 2 (50) | .36 (1.36) | 123 (465) | .25 (6) | 125 (8.6) |

Dimensional Tolerance: ±1/8" (± 3mm) • See service manual for complete specifications.

STANDARD FDA COMPLIANT PUMPS

PERFORMANCE & SPECIFICATIONS

FDA (Food & Drug Administration) Material Compliant Pumps are ideally suited for a variety of food processing, pharmaceutical and cosmetic industry applications. The pumps are available in 1" through 3" ball check valve designs and a 2" (line size solids handling) flap check valve design. Variable flow capacities across the range are 0–235 gallons per minute. These special duty pumps are constructed of FDA compliant material components of Stainless Steel (wetted castings) and a selection of FDA Santoprene®, FDA Nitrile and PTFE diaphragms, check valves and valve seats. Standard non-wetted components are white Epoxy Coated Aluminum with Stainless Steel hardware. 1", 1½", 2", 3" pumps are offered with sanitary clamp fittings and 3" pumps are offered with an ANSI flange.

Materials Of Construction
316 Stainless Steel components

Porting Options
Rotatable manifolds and top or bottom discharge available

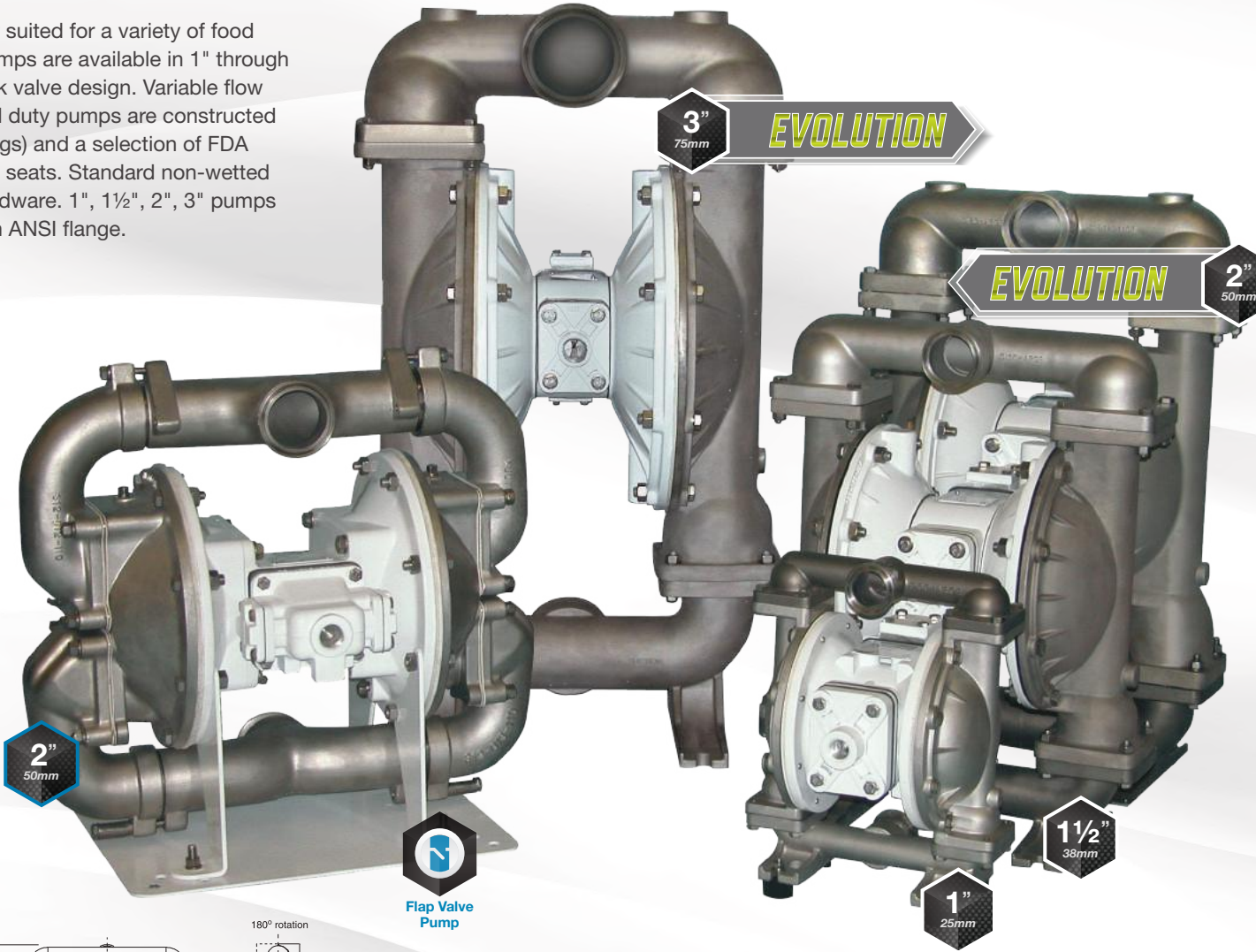

1" 25mm T1F Metallic Performance

MAX FLOW • 45 GPM (170 LPM) **PORTING** • Tri-Clamp **AIR END** • Epoxy Coated Aluminum **WET END** • Stainless Steel

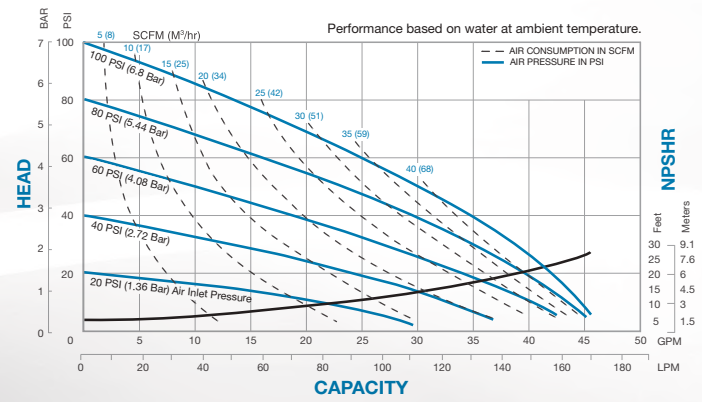

1½" 38mm T15 Metallic Performance

MAX FLOW • 106 GPM (401 LPM) **PORTING** • Tri-Clamp **AIR END** • Epoxy Coated Aluminum **WET END** • Stainless Steel

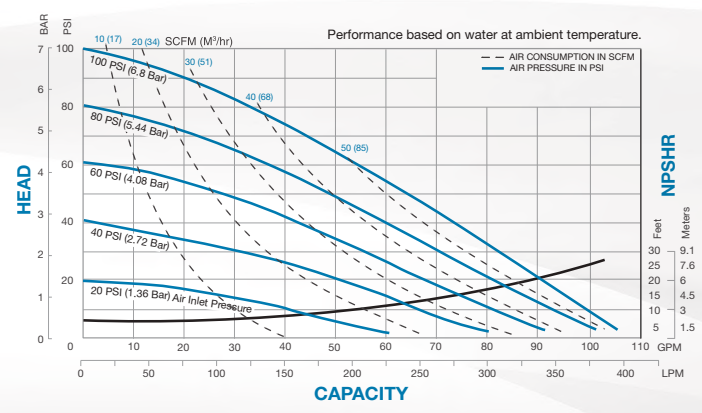

2" 50mm T20 Metallic Performance

MAX FLOW • 200 GPM (758 LPM) **PORTING** • Tri-Clamp **AIR END** • Epoxy Coated Aluminum **WET END** • Stainless Steel

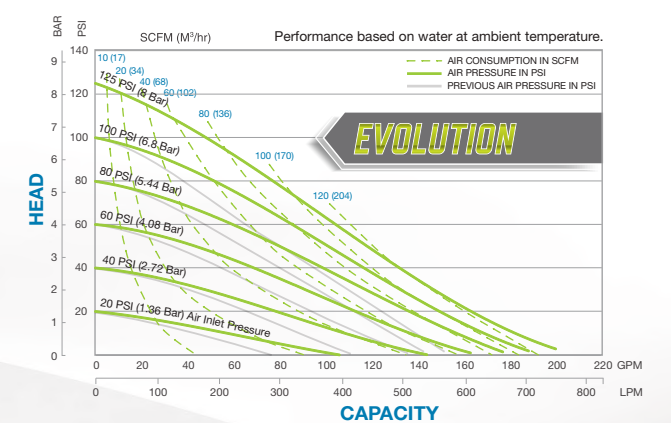

3" 75mm T30 Metallic Performance

MAX FLOW • 285 GPM (1,078 LPM) **PORTING** • ANSI Flange **AIR END** • Epoxy Coated Aluminum **WET END** • Stainless Steel

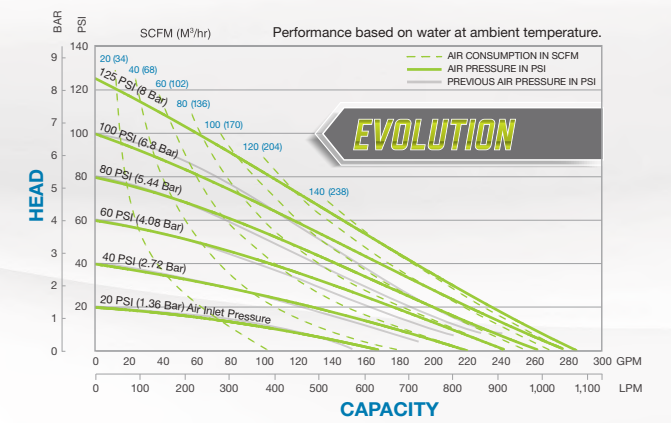

2" 50mm TSA2 Metallic Performance

MAX FLOW • 140 GPM (530 LPM) **PORTING** • Tri-Clamp **AIR END** • Epoxy Coated Aluminum **WET END** • Stainless Steel

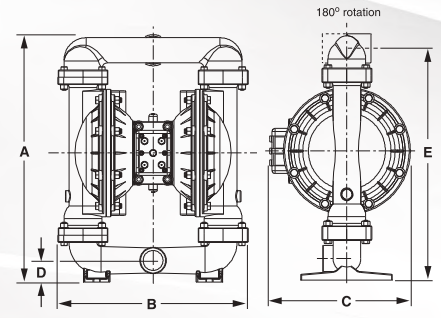
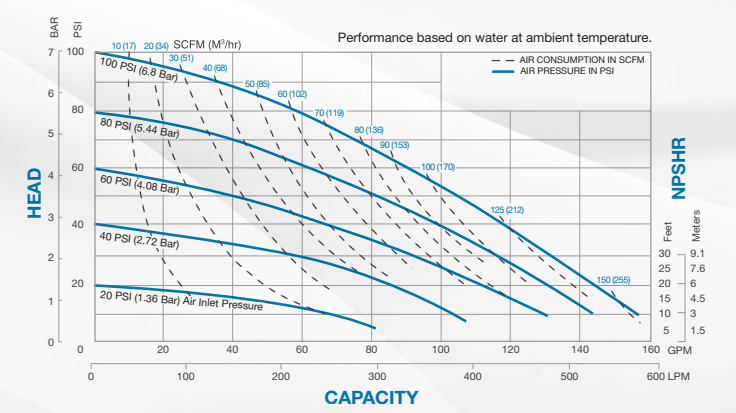

| PUMP MODELS | SPECIFICATIONS | | | | | Connection Style | Pipe Size | Displacement Per Stroke | Max Flow Per Minute | Max Solids Handling | Max Discharge Pressure |
|-------------|----------------|-------------|-------------|------------------------------------------|-----------------------|------------------|-----------|-------------------------|---------------------|---------------------|------------------------|
| | A | B | C | D | E | | | | | | |
| | Height | Width | Depth | Bottom of Base to Center Line of Suction | Center Line Discharge | | | | | | |
| T1F | 12.97 (326) | 10.25 (260) | 10.38 (264) | 1.22 (31) | 11.97 (304) | 1½" Tri-Clamp | 1 (25) | .11 (.42) | 45 (170) | .25 (6) | 125 (8.6) |
| T15 | 21.81 (554) | 16.66 (423) | 12.36 (314) | 1.97 (50) | 20.38 (518) | 2" Tri-Clamp | 1.5 (38) | .41 (1.55) | 106 (401) | .25 (6) | 125 (8.6) |
| T20 | 26.56 (674) | 16.88 (428) | 12.59 (320) | 2 (50) | 24.75 (629) | 2½" Tri-Clamp | 2 (50) | .42 (1.59) | 200 (758) | .25 (6) | 125 (8.6) |
| T30 | 32.28 (820) | 19.66 (499) | 15.75 (400) | 4.22 (107) | 30.84 (808) | 4" Tri-Clamp | 3 (75) | .94 (3.56) | 285 (1,078) | .38 (9.5) | 125 (8.6) |
| TSA2 | 20.81 (529) | 21.25 (539) | 13 (330) | 2.56 (65) | 17.56 (447) | 2½" Tri-Clamp | 2 (50) | .43 (1.60) | 140 (530) | 2 (50) | 125 (8.6) |

Dimensional Tolerance: ±1/8" (± 3mm) • See service manual for complete specifications.

EC-1935
Food Processing plastic and elastomer food contact components meet the requirements of EU Regulation 1935/2004/EC. Refer to declaration of conformity for compliant models.





Santoprene is a registered trademark of Exxon Mobil Corporation.

HIGH PRESSURE PUMPS

PERFORMANCE & SPECIFICATIONS

Air-Powered Single Diaphragm High Pressure Metallic Pumps deliver discharge pressure twice the inlet pressure, up to 250 PSI (17.2 BAR). Designed for filter press feed and applications requiring higher discharge pressures. Available in Aluminum, Cast Iron and Stainless Steel with various elastomer options. Equipped with elastomeric seals and components that are compatible with the various chemicals normally expected to be found in natural gas.

The Blagdon B25 and B50 High Pressure Pumps provide enhanced power in applications where pressure is paramount and flow rate is an issue. Using two air chambers to double the air per stroke, these pumps achieve discharge pressure up to 238 PSI (16 Bar) with flow rates as high as 28 GPM (106 LPM) for B25 and as high as 92 GPM (350 LPM) with B50.

-  **Maximum Flow Control**
High pressure capabilities allow for optimum control
-  **Heavy Duty**
Bolted construction and made with robust materials
-  **Unique Orientation**
Single end discharge and suction available
-  **Reliability**
Tested to ensure the long lasting performance
-  **Non-Freezing, Non-Stalling**
Patented air valve will never unexpectedly stop



ONLY High Pressure Flap Valve Pump in the WORLD

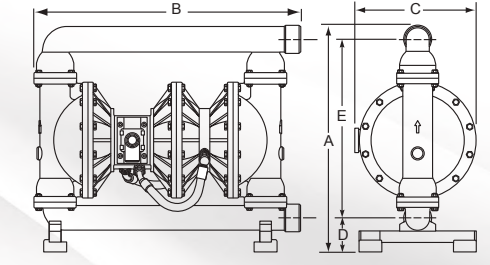
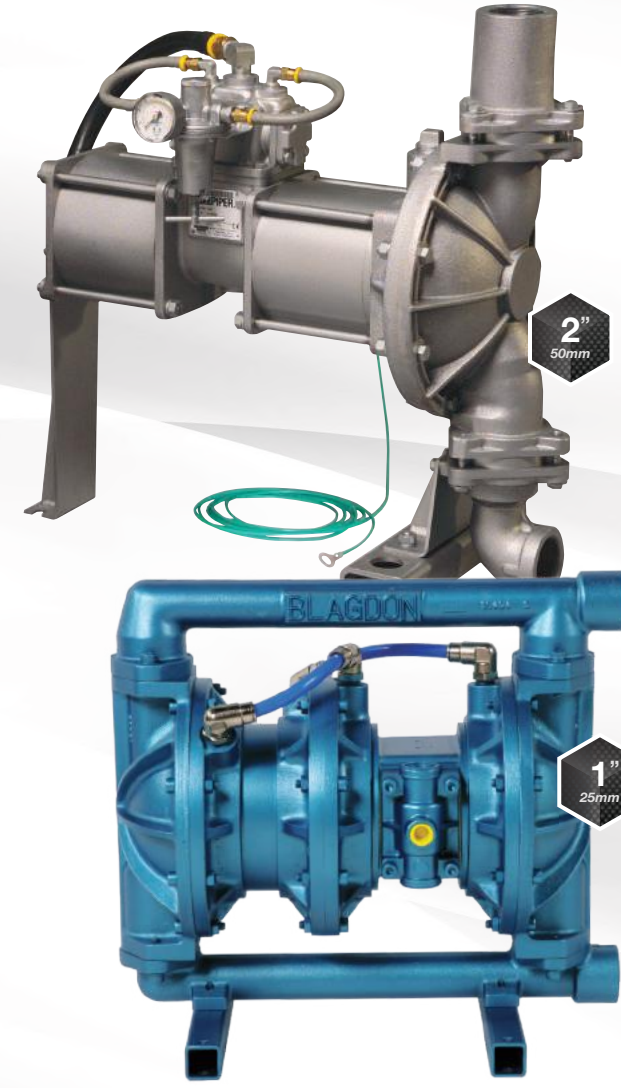

| PUMP MODELS | SPECIFICATIONS | | | | | Connection Style | Pipe Size | Displacement Per Stroke | Max Flow Per Minute | Max Solids Handling | Max Fluid Discharge Pressure | Max Air/Gas Inlet Pressure |
|-------------|----------------|-------------|-------------|-------------------------------------------|-------------|------------------|-----------|-------------------------|---------------------|---------------------|------------------------------|----------------------------|
| | A | B | C | D | E | | | | | | | |
| | Height | Width | Depth | Bottom of Base to Center Line of: Suction | Discharge | | | | | | | |
| EH2-M/GH2-M | 25 (635) | 25.81 (656) | 11.75 (298) | 2.18 (56) | 25 (635) | 2" NPT | 2 (50) | .36 (1.4) | 74 (280) | .25 (6) | 250 (17) | 125 (8.6) |
| SH2-M | 18.56 (471) | 26.87 (683) | 11.37 (289) | 11.47 (291) | 5.34 (136) | 2" NPT | 2 (50) | .30 (1.1) | 120 (454) | 2 (50) | 250 (17) | 125 (8.6) |
| B25 | 15.94 (405) | 18.27 (464) | 11.02 (280) | 1.97 (50) | 14.95 (380) | 1" BSP | 1 (25) | .13 (5) | 28 (106) | .13 (3) | 232 (16) | 117 (8) |
| B50 | 24.41 (620) | 28.70 (729) | 13.07 (332) | 3.66 (93) | 22.95 (583) | 2" BSP | 2 (50) | .42 (1.9) | 92 (350) | .25 (6) | 232 (16) | 117 (8) |

Dimensional Tolerance: ±1/8" (± 3mm) • See service manual for complete specifications.

2" 50mm EH2-M / GH2-M Metallic Performance

- MAX FLOW**
• 74 GPM (280 LPM)
- PORTING**
• NPT
- AIR END**
• E: Aluminum
• G: Cast Iron
- WET END**
• Cast Iron
• Stainless Steel

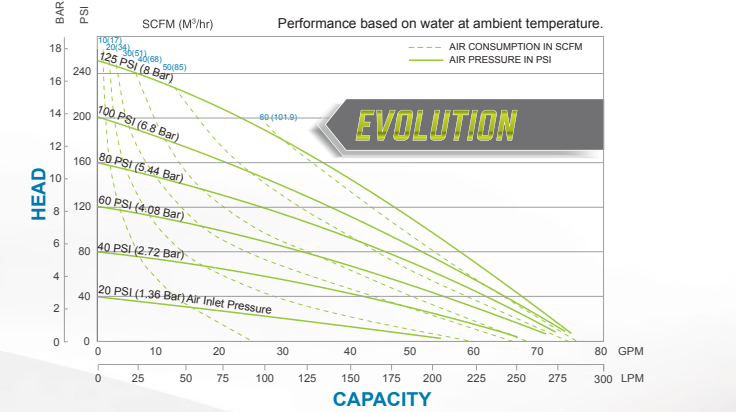

1" 25mm B25 Metallic Performance

- MAX FLOW**
• 28 GPM (106 LPM)
- PORTING**
• NPT / BSP
- AIR END**
• Aluminum
- WET END**
• Aluminum
• Stainless Steel

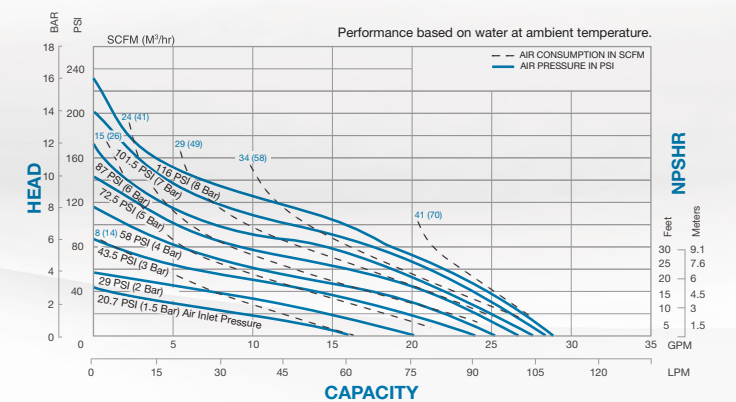

2" 50mm B50 Metallic Performance

- MAX FLOW**
• 92 GPM (350 LPM)
- PORTING**
• NPT / BSP
- AIR END**
• Aluminum
- WET END**
• Aluminum
• Stainless Steel

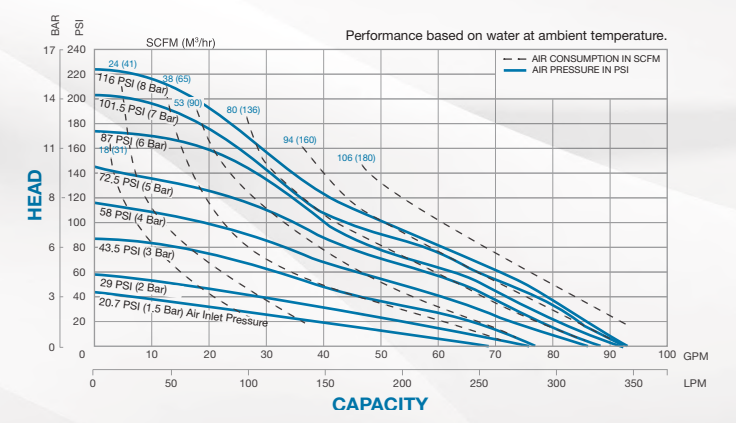

2" 50mm SH2-M Metallic Performance

- MAX FLOW**
• 120 GPM (454 LPM)
- PORTING**
• NPT
- AIR END**
• Aluminum
- WET END**
• Aluminum
• Cast Iron

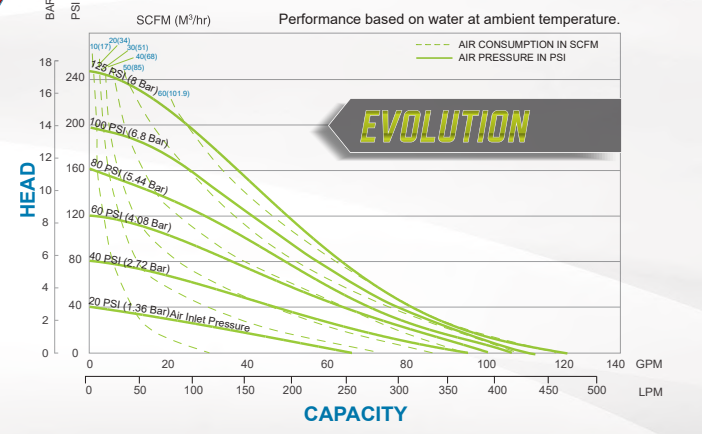

ACCESSORIES

ALL OF THE ITEMS YOU NEED TO COMPLETE YOUR SYSTEM

 **Enhanced Pump Performance and Productivity**

 **Extended MTBF (Mean Time Between Failure)**

 **Protection of Ancillary Equipment in Fluid Flow Path**

 **Enhanced Safety and Environmental Responsibility**

 **Precision Pump Control and Air Efficiency**

Liquid Level Control

Automatic, float actuated control unit that opens and closes the air supply to your AODD pump, especially useful in sump and liquid transfer situations.

[LEARN MORE ON PAGE 66](#)

Water Separator

This point-of-use water separator is designed to remove 99% of the water, rust and other contaminants commonly present in compressed air lines. Clean, dry air enhances the life and performance of pneumatically-driven equipment.

Electronic Speed Control

Provides accurate control of variable flow rates, from zero flow to maximum. Operates on 110 or 220VAC with on-board, single turn potentiometer or automatic mode for remote control using the optional 4-20 mA input terminal.

Air Filter / Regulator

Provides clean, dry air to your AODD pump. The SANDPIPER Filter / Regulator line offers modular convenience for easy installation and service.

[LEARN MORE ON PAGE 64](#)

Stroke Counter / Batch Control

Offers performance and repeatability with an interfaceable electronic control to program repetitive diaphragm pump operations. The complete system requires the Batch Controller, the Pulse Output Kit & the Air Line Solenoid.

Pulsation Dampener / Surge Suppressor

Provides virtually pulse-free discharge flow, for steadier pressure with less system vibration and noise. Our Tranquilizer® series is self-charging and self-venting.

[LEARN MORE ON PAGE 61](#)

Inlet Stabilizer

Blacoh® Sentry® Inlet Stabilizers reduce pressure fluctuations and assist pump head filling during each inlet stroke. In high suction applications, stabilizer will momentarily maintain the flow of the accelerated fluid.

Air Line Solenoid

Provides automatic on/off operation of air-driven equipment. 110/120VAC and 220/240VAC (50/60 hertz) kits operate with the SANDPIPER or customer's control units. 12VDC and 24VDC kits operate with customer-supplied controls only.

Muffler

Rugged polymer or metallic housing that work as effective sound dampening for SANDPIPER pumps, meeting OSHA dBA requirements.

Pulse Output Kit

Offered in a wide variety of sizes and voltages. These controls interface with the SANDPIPER Batch Controller, or your own process controls (PLCs). Available in kits for field installation, or factory built into a new pump.

Leak Detection

Electronic versions provide a signal via warning lights, an audible alarm, and the pump can be shut down.

Visual versions simply have a sight tube that fills with fluid if a diaphragm breaks.

Mechanical leak detection opens an air valve, which activates a customer supplied solenoid to trigger a signal. For use with the Containment Duty Spill Containment SANDPIPER pumps only.

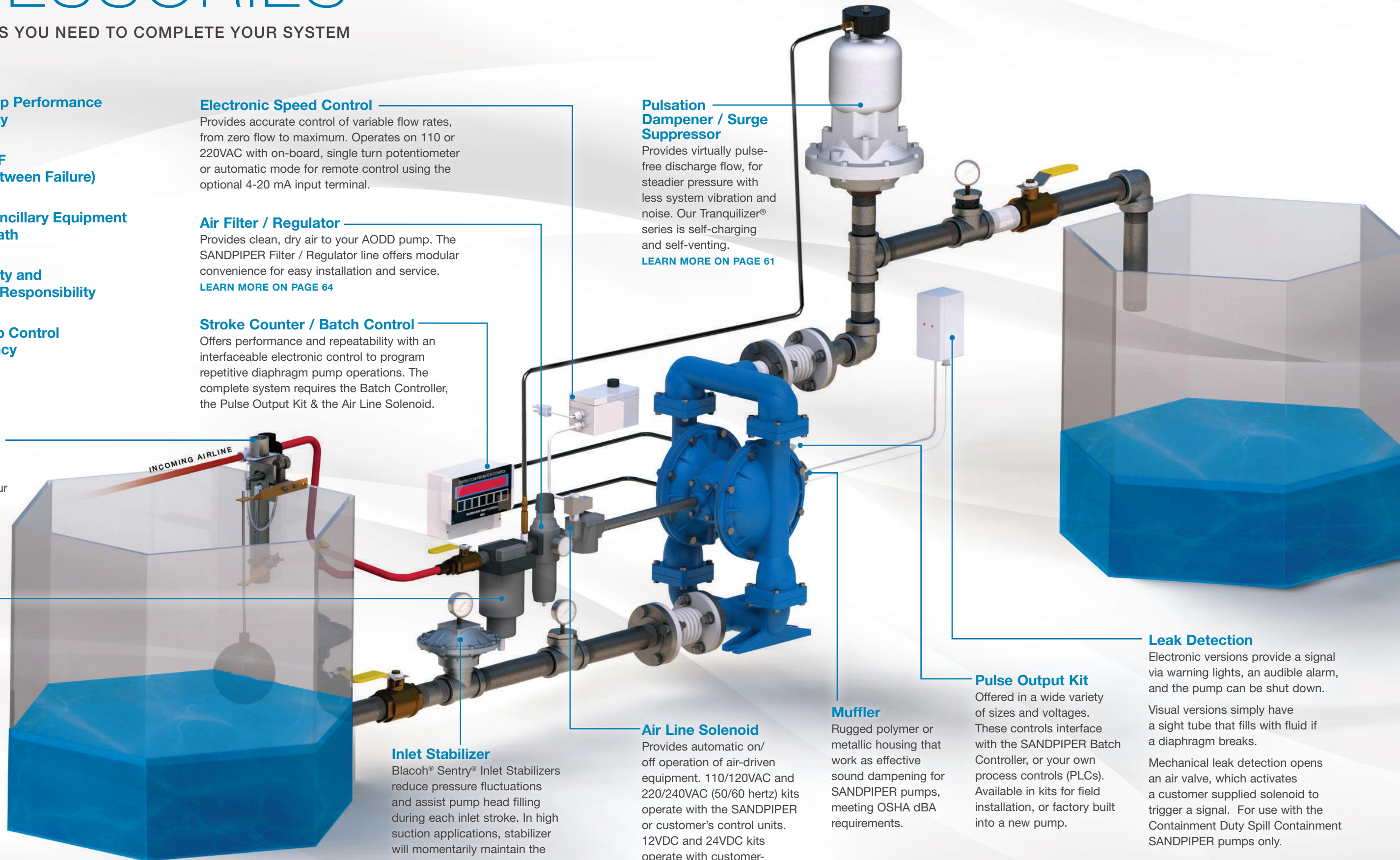

FILTER REGULATORS

RELIABLE FILTER / REGULATORS SPECIFICALLY DEVELOPED FOR AIR OPERATED DOUBLE DIAPHRAGM PUMPS

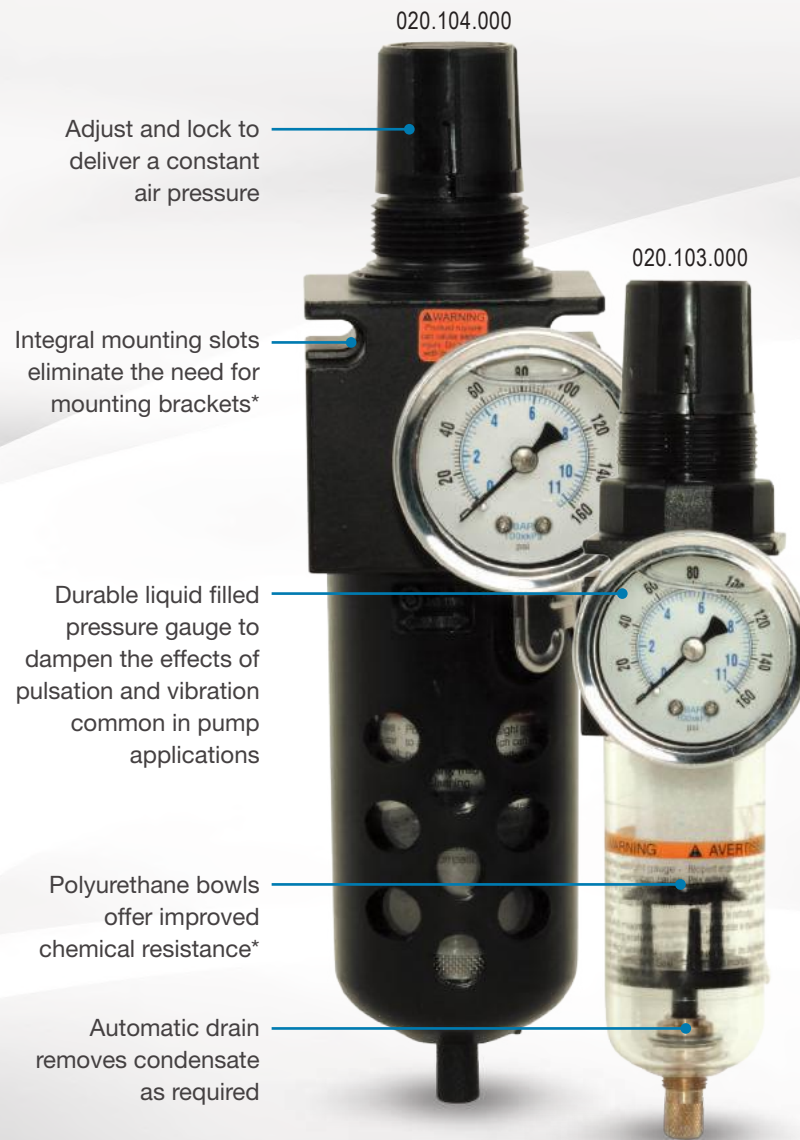

- Reduced Maintenance**
Clean, regulated air
- Lower Operating Costs**
Reduced air consumption and less compressor demand
- Extended Pump Life**
Reduced stress on wear components by proportioning the air pressure
- Reliable**
Engineered to optimize pump performance
- Protect**
Efficiently removing air line solids and liquid contaminants to protect air valve
- Safe Operation**
Operate at the lowest required air pressure
- Compact & Convenient**
Filter and regulate your air supply in a single, easy to install unit
- Precise Pump Control**
Easy air pressure adjustment to vary the pump's flow rate and operation speed

Lubricators

In applications with very dry air supplies or where nitrogen is being utilized to operate the pump, lubrication of the compressed air supply is required. For these situations, we offer a complete line of Lubricators that easily connect to our Filter / Regulators.



* Up to 3/4" units.

| TECHNICAL SPECIFICATIONS | | | | | | | | | | |
|----------------------------|-----------|-----------------|--------------------------------------------------------------|--------------------|---------------------------|----------------------------------------|---------------------------|----------------------------------|----------------------------------------|------------------------|
| Part Number | Port Size | Max Flow (SCFM) | Description | Max Inlet Pressure | Regulating Pressure Range | Replacement Filter Element Part Number | Lockout Valve Part Number | Mounting Bracket Kit Part Number | Replacement Pressure Gauge Part Number | Lubricator Part Number |
| 020.103.000 | 1/4" NPT | 35 | Filter/Regulator w/ gauge (20 micron) | 150 psi (10.2 bar) | 0 - 125 psi (0 - 8.6 bar) | 020.049.004 | 020.049.002 | 020.049.007 | 020.101.000 | 020.113.000 |
| 020.104.000 | 1/2" NPT | 80 | Filter/Regulator w/ gauge (40 micron) | 150 psi (10.2 bar) | 0 - 125 psi (0 - 8.6 bar) | 020.050.004 | 020.050.002 | 020.050.007 | 020.101.000 | 020.114.000 |
| 020.105.000 | 3/4" NPT | 150 | Filter/Regulator w/ gauge (40 micron) | 150 psi (10.2 bar) | 0 - 125 psi (0 - 8.6 bar) | 020.051.004 | 020.051.002 | 020.051.007 | 020.102.000 | 020.115.000 |
| 020.106.000 | 1" NPT | 250 | Filter/Regulator w/ gauge & mounting bracket kit (40 micron) | 175 psi (12.1 bar) | 0 - 125 psi (0 - 8.6 bar) | 020.052.004 | 020.052.002 | 020.052.007 | 020.102.000 | 020.116.000 |
| 020.107.000 for AirVantage | 1" NPT | 250 | Filter/Regulator w/ gauge & mounting bracket kit (20 micron) | 175 psi (12.1 bar) | 0 - 125 psi (0 - 8.6 bar) | 020.070.004 | 020.052.002 | 020.052.007 | 020.102.000 | Not Recommended |

Temperature Ratings: 40°F to 125°F (4.4°C to 52°C).

TRANQUILIZERS®

PULSATION DAMPENERS / SURGE SUPPRESSORS

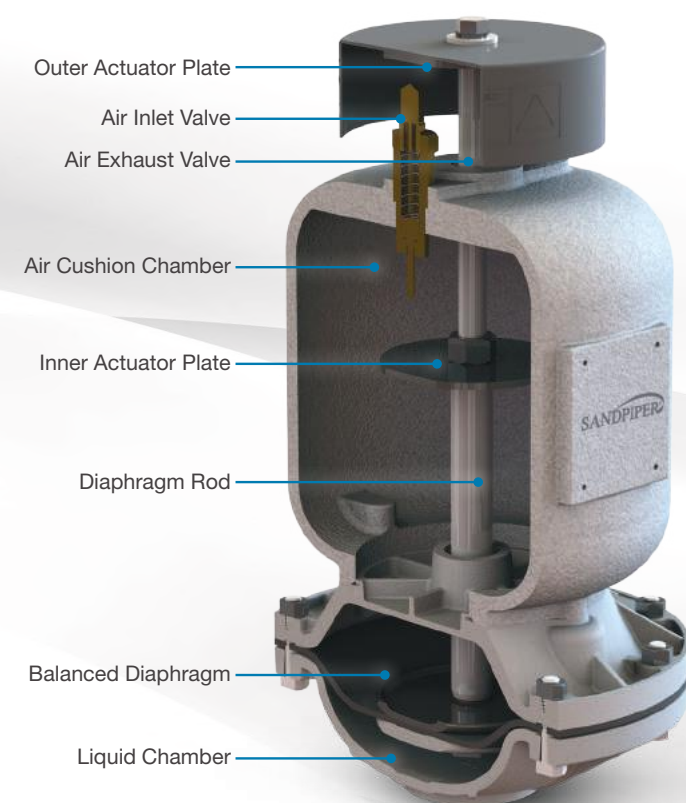
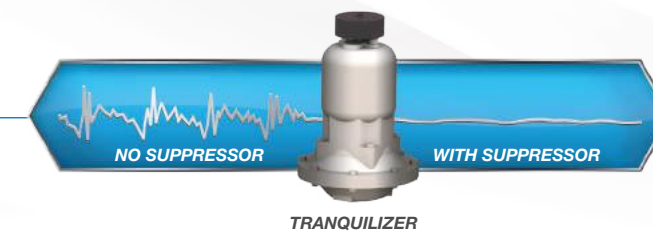

- Virtually surge-free flows**
- Steadier pressures**
- Less vibration and noise**
- Simple installation**
- Automatically self-charging and self-venting**
- Longest life balanced diaphragm**
- Capable of pressures to 125 PSI (8.6 BAR)**
- Protects other system components**



SCAN TO LEARN MORE
SANDPIPERPUMP.COM/SURGEDAMPENERS



| TECHNICAL SPECIFICATIONS | | | | | | | Available Wetted Materials | | | | | | | | | | | |
|--------------------------------|---------|-------------------|----------------|----------------------------|--------------------------------------|---------------------------------------|----------------------------|-----------------|-------------------------------------------|---------|-----------|---------|-----|------|-----------------------|-------------|---|---|
| Model | Desc. | Cert. | Air Inlet Size | Liquid Inlet Size | Height (mm) | Diameter (mm) | Chamber | | | | Diaphragm | | | | | | | |
| | | | | | | | Aluminum | Stainless Steel | Cast Iron | Alloy C | Neoprene | Nitrile | FKM | EPDM | Neoprene PTFE Overlay | Santoprene® | | |
| Tranquilizers (Featured Above) | TA1 | 1" pumps | Ex CE | 1/4" NPT (external thread) | 1" NPT | 13.625"-15.125" (346mm-384mm) | 9" | (229mm) NPT(F) | ✓ | ✓ | ✗ | ✗ | ✓ | ✓ | ✓ | ✓ | ✓ | ✓ |
| | TA25 | 1" pumps | Ex CE | 1/4" NPT (external thread) | 1" BSP (tapered internal thread) | 13.625"-15.125" (346mm-384mm) | 9" | (229mm) NPT(F) | ✓ | ✓ | ✗ | ✗ | ✓ | ✓ | ✓ | ✓ | ✓ | ✓ |
| | TA1 1/2 | 1" & 1 1/2" pumps | Ex CE | 1/4" NPT (external thread) | 1 1/2" NPT (internal thread) | 19.875"-21.325" (505mm-543mm) | 10.5" | (267mm) NPT(F) | ✓ | ✓ | ✓ | ✓ | ✓ | ✓ | ✓ | ✓ | ✓ | ✓ |
| | TA40 | 1" & 1 1/2" pumps | Ex CE | 1/4" NPT (external thread) | 1 1/2" BSP (tapered internal thread) | 19.875"-21.325" (505mm-543mm) | 10.5" | (267mm) NPT(F) | ✓ | ✓ | ✓ | ✓ | ✓ | ✓ | ✓ | ✓ | ✓ | ✓ |
| | TA2 | 1 1/2" & 2" pumps | Ex CE | 1/4" NPT (external thread) | 2" NPT (internal thread) | 20.25"-23.1875" (514mm-589mm) | 12.5" | (317mm) NPT(F) | ✓ | ✓ | ✓ | ✓ | ✓ | ✓ | ✓ | ✓ | ✓ | ✓ |
| | TA50 | 1 1/2" & 2" pumps | Ex CE | 1/4" NPT (external thread) | 2" BSP (tapered internal thread) | 20.25"-23.1875" (514mm-589mm) | 12.5" | (317mm) NPT(F) | ✓ | ✓ | ✓ | ✓ | ✓ | ✓ | ✓ | ✓ | ✓ | ✓ |
| | TA3 | 3" pumps | Ex CE | 1/4" NPT (external thread) | 3" 150# ANSI (internal thread) | 20.125"-23.125" (511mm-587mm) | 16.1875" | (411mm) NPT(F) | ✓ | ✓ | ✓ | ✗ | ✓ | ✓ | ✓ | ✓ | ✓ | ✓ |
| | TA80 | 3" pumps | Ex CE | 1/4" NPT (external thread) | 3" BSP (tapered int.) OR 80mm DIN | 20.125"-23.125" (511mm-587mm) | 16.1875" | (411mm) NPT(F) | ✓ | ✓ | ✓ | ✗ | ✓ | ✓ | ✓ | ✓ | ✓ | ✓ |
| Dampeners | DA05 | 1/2" pumps | CE | 1/4" NPT (external thread) | 1/2" NPT (internal thread) | 7.468" (190mm) WIDTH: 5.625" (143mm) | 6.9375" | (176mm) | Aluminum, Stainless Steel & Polypropylene | | | | | | | | | |
| | DA07 | 3/4" pumps | CE | 1/4" NPT (external thread) | 3/4" NPT (internal thread) | 7.718" (196mm) WIDTH: 5.625" (143mm) | 6.9375" | (176mm) | Polypropylene only | | | | | | | | | |
| | DA10 | 1" pumps | CE | 1/4" NPT (external thread) | 1" NPT (internal thread) | 11.718" (298mm) WIDTH: 5.625" (143mm) | 7.5" | (191mm) | Polypropylene only | | | | | | | | | |

✓ = Available ✗ = Not available

All of the TA models are CE and ATEX • Dimensional Tolerance: ±1/8" (±3mm). • See service manual for complete specifications.

LIQUID LEVEL CONTROL

AUTOMATIC, FLOAT ACTUATED UNIT THAT OPENS AND CLOSES AIR SUPPLY TO YOUR AODD PUMP

How it Works

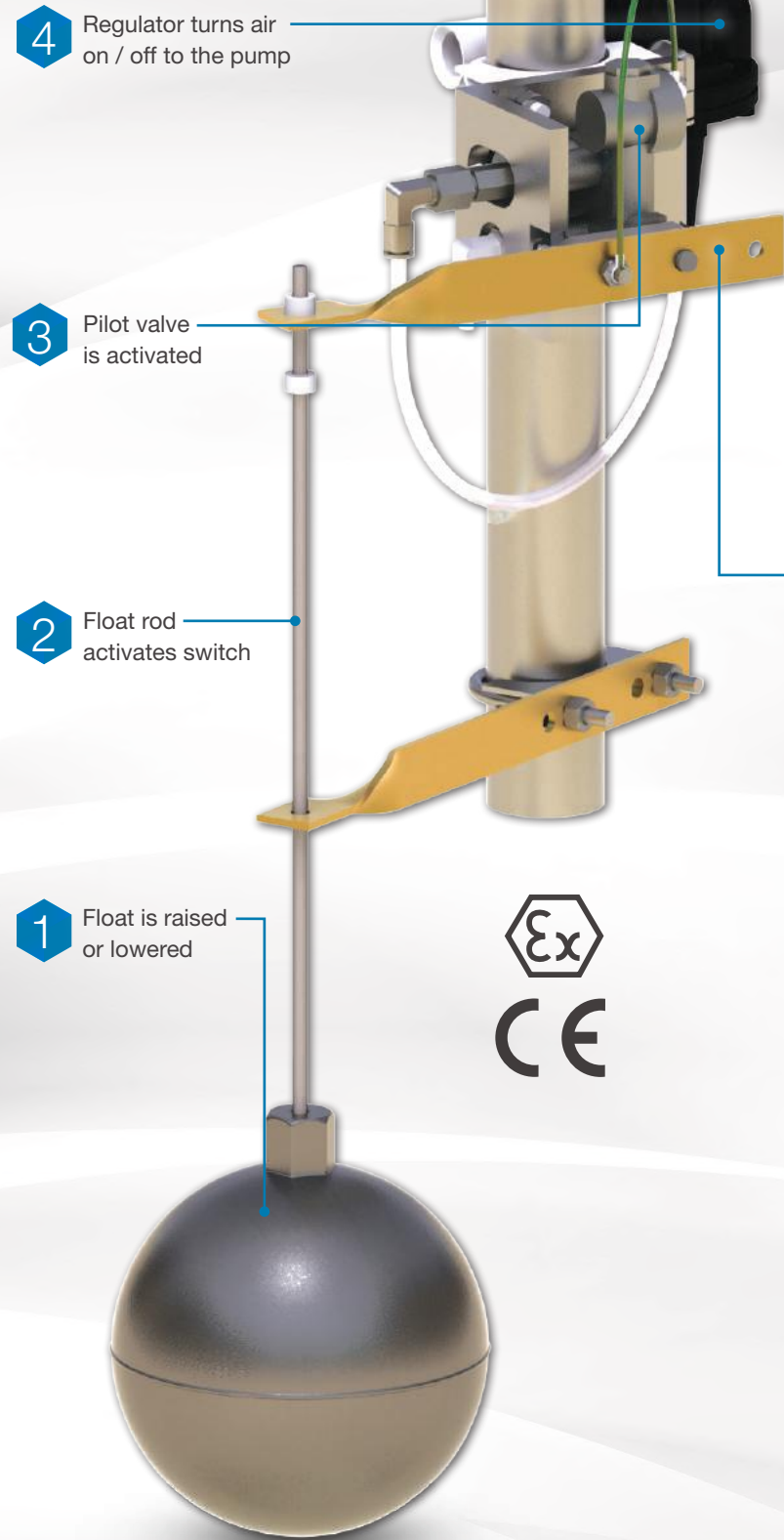

- Pneumatic**
No electrical power required
- Adjustable**
Operating range from a few inches to 9 ft (2.7 m)
- Simple**
Easy to install & operate
- Versatile**
Quick reversible operation
- Universal**
Can be used with all AODD pumps
- Reliable**
Stainless steel float & connecting rod

Reversible Operation

Operation can be reversed by installing the top float rod bracket in the opposite direction from position shown.

Standard Operation

High Level = On, Low Level = Off

Reverse Operation

High Level = Off, Low Level = On

Common Applications



Sumps



Dewatering



Fluid Transfer



Tank Filling



ADDITIONAL ACCESSORIES

OTHER ACCESSORIES THAT SANDPIPER OFFERS TO HELP COMPLETE YOUR PROCESS



The **ONLY** CSA Certified point-of-use natural gas regulators available on the market today!

A safety port has been added to help prevent escaping gas in the case of a regulator diaphragm rupture. Simply add a pipe or hose fitting to the unit to divert or reclaim any natural gas.

SANDPIPER Natural Gas Pressure Regulators are safe, reliable and environmentally friendly. These exclusive CSA Certified and UL Listed point-of-use regulators provide superior regulation and excellent stability. All regulators include a durable glycerin filled pressure gauge to dampen the effects of pulsation and vibration common in pump applications.

TECHNICAL SPECIFICATIONS

| Part Number | Port Size | Max Flow (SCFM) | Pump Models | Max Inlet Pressure | Regulating Pressure Range | Temperature Rating | Materials of Construction |
|-------------|-----------|-----------------|-------------|--------------------|---------------------------|----------------------------------|----------------------------------------------|
| 020.057.000 | 1/4" NPT | 25 | G05 | 250 PSI (17.2 BAR) | 0 - 120 PSI (0 - 8.3 BAR) | 0°F - 160°F (-17.8°C - 71.1°C) | Aluminum, Brass, Plated Steel, Nitrile |
| 020.058.000 | 1/2" NPT | 110 | G1F, G10F | 400 PSI (27.6 BAR) | 0 - 125 PSI (0 - 8.6 BAR) | -40°F - 200°F (-40.0°C - 93.3°C) | Zinc, Aluminum, Plated Steel, Nitrile, Brass |
| 020.059.000 | 3/4" NPT | 110 | G15, G20 | 400 PSI (27.6 BAR) | 0 - 125 PSI (0 - 8.6 BAR) | -40°F - 200°F (-40.0°C - 93.3°C) | Zinc, Aluminum, Plated Steel, Nitrile, Brass |
| 020.060.000 | 3/4" NPT | 260 | G20F, G30 | 400 PSI (27.6 BAR) | 0 - 125 PSI (0 - 8.6 BAR) | -40°F - 200°F (-40.0°C - 93.3°C) | Zinc, Aluminum, Plated Steel, Nitrile, Brass |

Diaphragm Material: Nitrile elastomer with polyester fabric
All gauge ports & vent ports are tapped 1/4" NPT
Replacement pressure gauge part number: 020.061.000

Note: The use of a relief valve is recommended for these products in accordance with NFPA 58.

Natural Gas Filters

SANDPIPER Natural Gas Filters provide superior particulate protection from systems with high concentrations of solid contaminants. These point-of-use filters are built from durable and lightweight aluminum, feature very high dirt-holding capacity and offer lower pressure drop than other comparable products.

TECHNICAL SPECIFICATIONS

| Part Number | Port Size | Max Flow (SCFM) | Pump Models | Replacement Filter Element | Max Inlet Pressure | Max Temperature | Materials of Construction |
|-------------|-----------|-----------------|---------------------------|----------------------------|--------------------|-----------------|------------------------------------------------------------|
| 020.062.000 | 1/4" NPT | 25 | G05 | 020.065.000 | 500 PSI (34 BAR) | 175°F (80°C) | Aluminum Housing, Nitrile Seals, Molded Urethane End Seals |
| 020.063.000 | 1/2" NPT | 42 | G1F | 020.065.000 | | | |
| 020.064.000 | 3/4" NPT | 133 | G10F, G15, G20, G20F, G30 | 020.066.000 | | | |

Stainless Steel manual drain 1/8" NPT
Micron Rating: 3



DIAPHRAGM SELECTION

GET THE MAXIMUM LONGEVITY OUT OF YOUR SANDPIPER PUMP BY SELECTING THE APPROPRIATE DIAPHRAGM FOR YOUR APPLICATION

The Synthesis Diaphragm

A premium one-piece diaphragm that creates optimum conditions for high performance pumping and reliability. Expect longer service life and reduced maintenance costs with this premium diaphragm.

Temperature Range
14°F to 176°F (-10°C to 80°C)

Torque-Free Installation
Simply hand turned into position

No Center Hole for superior leak free operation and installation

No Outer Diaphragm Plate Abrasion due to trapped fluids

Oversized Integrated Plate supports nearly 50% of the diaphragm through the entire dynamic motion

Start-Up Pressure of less than 10 PSI on SANDPIPER Synthesis Diaphragm vs. 25 PSI or more on competitive diaphragms

One-Piece Composite Design with 100% PTFE on the wetted side bonded to a Nitrile Rubber Backer (NRB) with an integrated diaphragm plate

Two-piece Diaphragm

The standard PTFE diaphragm offered with SANDPIPER pumps is the two-piece diaphragm—a cost effective solution for a large variety of pumping applications. Some of the main features of this diaphragm include:

- Wide range of pressure capabilities
- Variety of materials available
- Proven performance over years of testing

Please consult your distributor or factory experts for additional details.

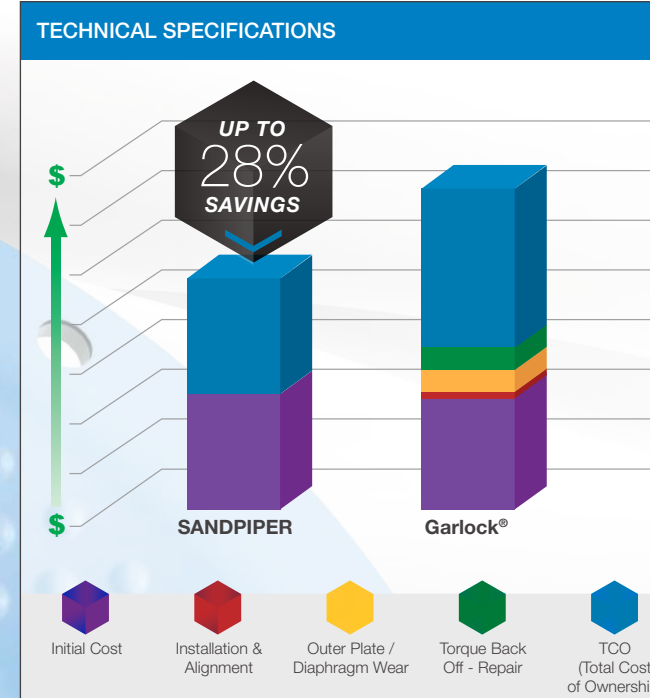

Garlock® is a registered trademark of EnPro Industries, Inc.

| TECHNICAL SPECIFICATIONS | | | | |
|-------------------------------|-------------------------|----------------------------|-------------|------------------|
| Part Number (Conversion Kit)* | Inner Diaphragm Plate** | Where Used | Wet End Kit | Where Used |
| 286.112.000 (475.250.000) | 612.218.330 | SB1 | 476.034.659 | SB1-A |
| 286.112.000 (475.250.000) | 612.218.330 | S1F Metallic | 476.194.659 | S1F Metallic |
| 286.113.000 (475.254.000) | 612.217.150 | S15 Metallic | 476.182.659 | S15 Metallic |
| 286.114.000 (475.255.000) | 612.219.150 | HDB1½ | 476.036.659 | HDB1½ |
| 286.114.000 (475.256.000) | 612.227.150 | S15 Non-Metallic | 476.255.659 | S15 Non-Metallic |
| 286.114.000 (475.256.000) | 612.227.150 | S20 Non-Metallic | 476.257.659 | S20 Non-Metallic |
| 286.115.000 (475.258.000) | 612.220.150 | S1F Non-Metallic | 476.197.659 | S1F Non-Metallic |
| 286.116.000 (475.251.000) | 612.221.330 | S05, S07, S10 Non-Metallic | 476.202.659 | S05 Non-Metallic |
| 286.116.000 (475.251.000) | 612.221.330 | S05 Metallic | 476.199.659 | S05 Metallic |
| 286.118.000 (475.252.000) | 612.215.330 | HDB2 | 476.043.659 | HDB2 |
| 286.118.000 (475.253.000) | 612.214.150 | S20 Metallic | 476.042.659 | S20 Metallic |

*Conversion Kits include (2) Diaphragms w/Studs and (2) Inner Plates.
**Order this Inner Diaphragm Plate when ordering the One-Piece Diaphragm.

MATERIAL SELECTION GUIDE

| Diaphragm Material | Purchase Price | Flex Life | Abrasion Resistance | Chemical Resistance | Temp. Limitations | Temp. Max. Operating | Temp. Min. Operating |
|--------------------|----------------|-----------|---------------------|---------------------|-------------------|----------------------|----------------------|
| EPDM | ✓ | ✓ | ✓ | ✓ | + | 280°F / 138°C | -40°F / -40°C |
| FKM | ! | X | ! | + | + | 350°F / 177°C | -40°F / -40°C |
| Hytre® | ✓ | + | + | ✓ | ✓ | 220°F / 104°C | -20°F / -29°C |
| Neoprene | + | + | ✓ | X | ✓ | 200°F / 93°C | -10°F / -23°C |
| Nitrile | + | + | ✓ | ! | ✓ | 190°F / 88°C | -10°F / -23°C |
| Santoprene® | + | + | + | + | + | 275°F/135°C | -40°F/-40°C |
| Urethane | + | ✓ | ! | X | ! | 150°F / 66°C | 32°F / 0°C |
| PTFE Synthesis | ! | ✓ | ! | + | ! | 176°F / 80°C | 14°F / -10°C |
| PTFE Two-Piece | ! | ! | X | + | ✓ | 220°F / 104°C | -35°F / -37°C |

For reference only, consult distributor.

+

✓ = Best Type

! = Suitable

X = Limitations

X = Not Recommended

Santoprene® is a registered trademark of Exxon Mobil Corp. Hytre® is a registered trademark of E.I. DuPont.

GENUINE PARTS SERVICE KITS

SANDPIPER HAS A SOLUTION WHETHER YOUR AODD PUMP NEEDS QUICK, URGENT CARE OR A FULL SERVICE REPAIR

Repair it Once, Repair it Right

Everything in One Place
All of the parts you need to get running again

Reduce Frequency of Repairs
Reliable replacement parts are guaranteed to last

Increase Uptime
Maximize your productivity with fewer repairs

Save Time and Money
Ordering and repairs made easy

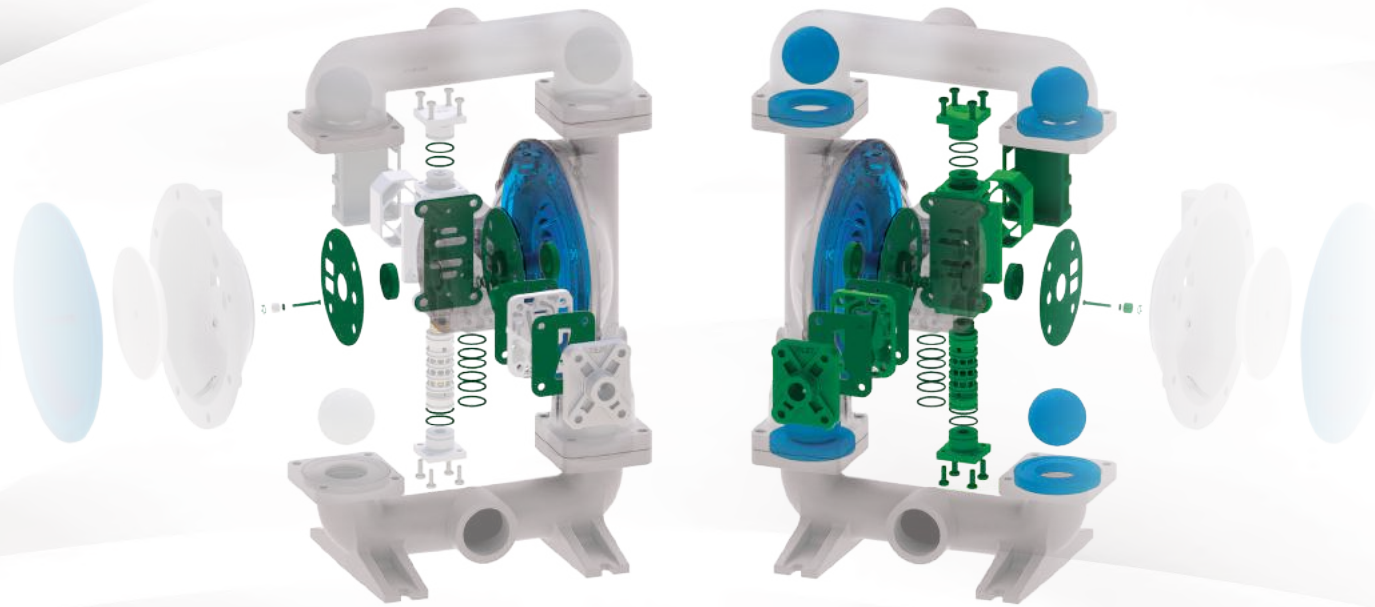

Wear Kits

Wet End Wear Kit:

- Diaphragms

Air End Wear Kit:

- Gaskets
- O-rings
- Seals
- Lubricant

Repair Kits

Wet End Repair Kit:

- Diaphragms
- Balls
- Seats

Air End Repair Kit:

- Seals
- O-rings
- Gaskets
- Retaining Rings
- Air Valve Sleeve & Spool
- Pilot Valve Assembly
- Lubricant



SANDPIPER is pleased to offer you the trusted Genuine Parts you need, sold in convenient kits or individual parts. Whatever you need to make pump repairs, we have you covered.

USE ONLY GENUINE SANDPIPER PARTS

All certification, standards, guarantees & warranties originally supplied with this pump will be invalidated by the use of service parts not identified as "Genuine SANDPIPER Parts."



SANDPIPER'S EXTERNALLY SERVICEABLE AIR DISTRIBUTION SYSTEM (ESADS+PLUS)

SANDPIPER's Externally Serviceable Air Distribution System (ESADS) allows for quick and easy access to the pilot and spool valves without removing the pump from service, maximizing up time!

SANDPIPER

VS

COMPETITORS



The Air Motor's Pilot Valve is the Most Often Serviced Part on an AODD Pump



5 MINUTES FOR MAINTENANCE / CLEANING
Accomplished in minutes without removing pump from service by removing only 4 bolts



Saves you money by minimizing downtime



55 MINUTES OR LONGER FOR MAINTENANCE / CLEANING
The air valve components can only be accessed by removing the pump from service and taking it entirely apart



Costs you money due to extended downtime

SANDPIPER VS COMPETITION

HEAVY DUTY FLAP VALVE PUMP

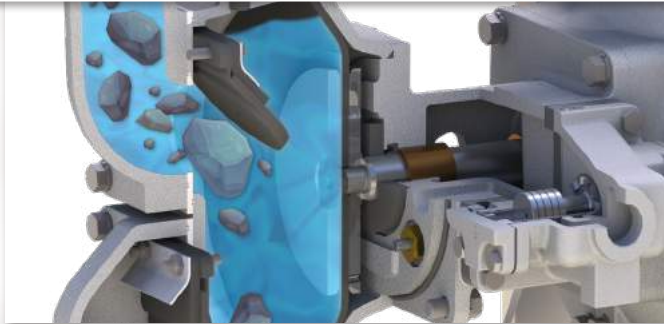

Large solids easily pass through pump

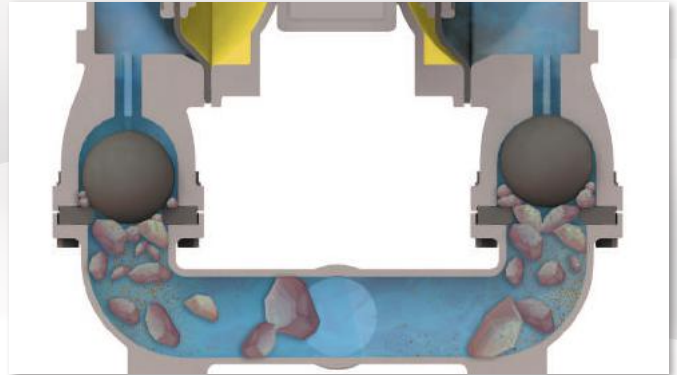

Large solids cannot pass through pump, affecting operation

HEAVY DUTY BALL VALVE PUMP

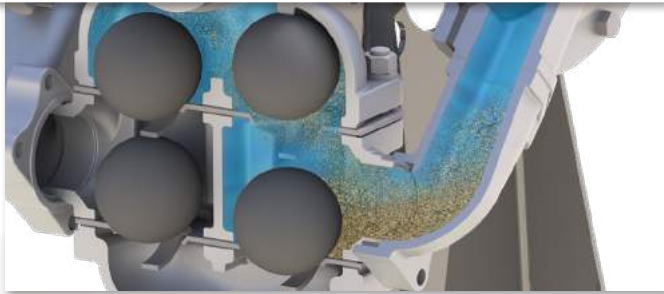

Settling solids easily pass through pump

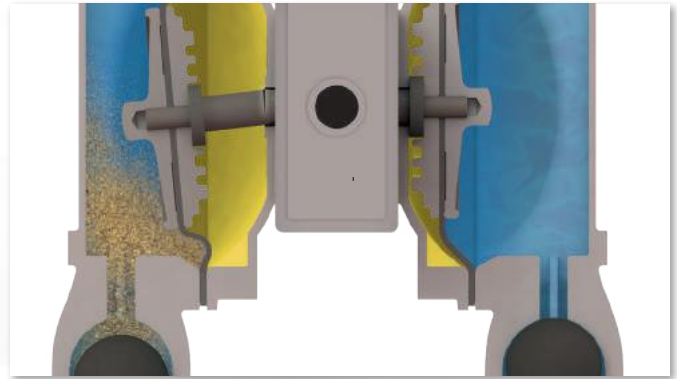

Settling solids collect inside pump, causing damage & affecting operation

CONTAINMENT DUTY PUMP

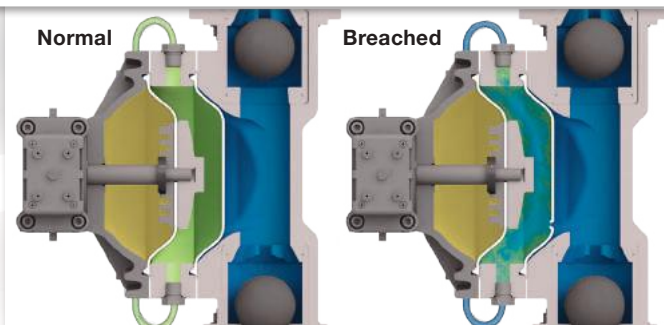

Contains fluid when diaphragm becomes breached

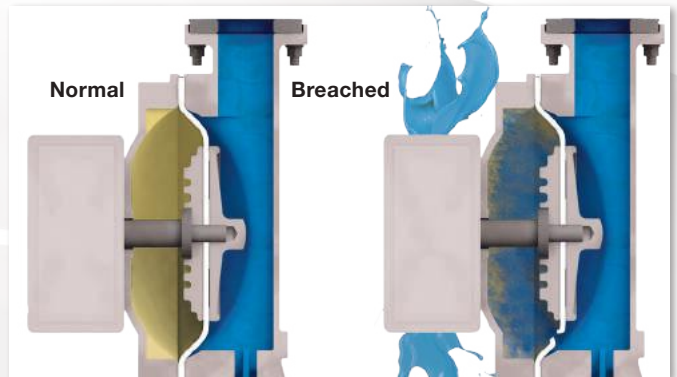

Fluid escapes to environment when diaphragm becomes breached.

SANDPIPER[®]

Warren Rupp, Inc. | A Unit of IDEX Corporation
800 North Main Street, Mansfield, OH 44902 USA
Phone: 419.524.8388 | Fax: 419.522.7867
SANDPIPERPUMP.COM



Contact Your Local Distributor to Place Your Order:

IDEX